

OCTOBER 2007

EQUATIONS
COLLECTION
PRICE LIST

MAGNA
DESIGN

EQUATIONS and EQUATIONS² Table of Contents

General Information: Warranty, etc 4
Specifications 6

Equations Standard Components - Available on MAGNA NOW! 10 day ship program, except for glass doors

Worktop Edge Profiles:



Smooth Reeded NeoClassic

PVC: WPES WPER WPEN

Wood: SWES SWER SWEN

WoodPlus is a unique combination of wood products and resins thermofused under high temperature and pressure. Worktops are WoodPlus high pressure.

Hutches, ends, flipper doors use Smooth PVC edge WPES, or Smooth Wood edge SWES.

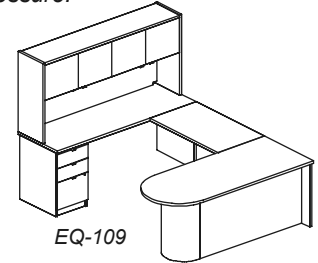
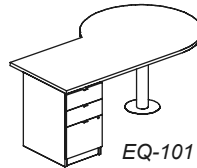

Finishes 9
Configurations 11
Components 13 to 39
Introduction for component parts 40
Finshes 43
Component Parts 44 to 49

Equations² Components

WoodPlus² is a polymer material thermoformed under pressure and vacuum into a seamless, one-piece surface with an integrated edge.

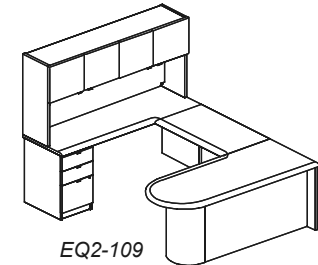
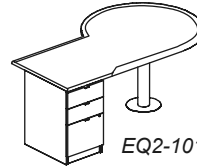
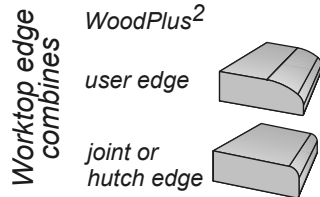

Configurations, Finishes 50
Components: 55 to 75

Equations² Shapes Components

WoodPlus² is a polymer material thermoformed under pressure and vacuum into a seamless, one-piece surface with an integrated edge.

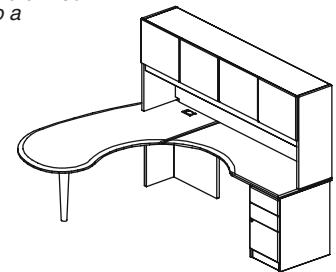
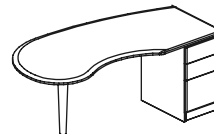
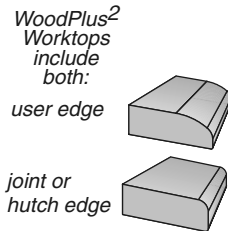

Configurations, Finishes 76
Components: 81 to 93

Accessories 94

Model Number key 97

Index 98

Equations Standard models using WoodPlus finishes are available on Magna NOW! - 10 day ship program, except for models with glass doors..

Pricing and Delivery Information

PRICES:

Prices are subject to change without notice and the price list with the later date supersedes all previous price lists.

Prices do not include charges for cartoning, installation, or inside delivery.

Cartoning charges will be added to orders weighing under 250 lb.

DELIVERY:

All prices include delivery outside the Zone 1 region.

Zone 1 includes Washington, Oregon, Alaska, Hawaii, and British Columbia. Prices in Zone 1 reflect Factory Will Call. Zone 1 dealer discounts are adjusted accordingly.

A freight surcharge will be added to Zone 2 orders totaling less than \$5,000 LIST. The freight surcharge will be 10% of NET invoice total.

A Fuel Surcharge will be added to all orders that include delivery. Please see our website <http://www.magnadesig.com> for current details.

Standard delivery will be made on a dock-to-dock basis or to a sidewalk. Should you have special requirements such as inside delivery or prior notification please contact Magna Design's traffic department. Special delivery requirements will be handled on an as-available basis and will likely result in additional charges.

All Shipments are FOB Magna Plant, Lynnwood, Washington.

MagnaCad Information



MagnaCad

The MagnaCad graphic and specification package includes the complete Equations symbol library for 2D layout drawings and 3D isometric illustrations. The Equations symbol library is linked directly to specification and pricing information.

Access Equations components by model or description. Both left and right orientations are provided as needed for each model.

Equations product graphic and specification packages are available for use with 20-20 GIZA software, Data One's Design Express software and Project Matrix's Project Spec software. Software such as 20-20 GIZA, Design Express or Project Spec may be purchased directly from the software provider. Magna provides just the graphic and specification information for our product lines that can be used in these third party software products.

LIFETIME Limited Warranty

MAGNA DESIGN warrants that its products are free from defects in design, material, and workmanship under normal use and with proper care and maintenance. This warranty will remain in effect for the following period of time, commencing with the date of purchase from MAGNA DESIGN but only so long as the original purchaser continues to own the product:

- WoodPlus2 finishes on products purchased January 2002 or later - **LIFETIME**
- Drawer slides - **LIFETIME**
- **LIFETIME for ALL PRODUCT and COMPONENTS**, not listed below
- Healthcare products - **ten (10) years**
- Electrical components and functional mechanisms, like keyboard trays - **five (5) years**
- Wood finishes - **three (3) years.**

During the term of this Warranty, MAGNA DESIGN will repair or replace with the same or comparable product or part without charge any product or part that malfunctions or fails to conform to this Warranty. THIS REMEDY OF REPAIR OR REPLACEMENT IS PURCHASER'S SOLE AND EXCLUSIVE REMEDY WITH REGARD TO ANY PRODUCT DEFECT.

This Warranty does not apply to:

- Any damage caused during shipment.
- Any product installed or used other than in accordance with MAGNA DESIGN guidelines.
- Any product that has been repaired, altered, or modified by any person other than MAGNA DESIGN.
- Any attachment added to a product.
- Any fabric or upholstery material.
- Any part or material provided by Purchaser.
- Any damage caused by misuse, abuse, or negligence on the part of Purchaser or any third party.

THERE ARE NO OTHER WARRANTIES, EITHER EXPRESSED OR IMPLIED, INCLUDING ANY WARRANTY OF MERCHANTABILITY OR OF FITNESS FOR A PARTICULAR PURPOSE. UNDER NO CIRCUMSTANCES WILL MAGNA DESIGN BE LIABLE FOR ANY CONSEQUENTIAL OR INCIDENTAL DAMAGES ARISING FROM ANY PRODUCT DEFECT.

This warranty is in effect for products shipped on or after May 1, 1998.

Terms and Conditions

QUOTATIONS:

Price quotations on non-catalog or special orders will not be valid after thirty (30) days without written approval from Magna Design, Inc.

CREDIT TERMS

Net thirty (30) days after invoice date upon credit approval.

ORDERING :

When ordering, please include complete identification and description of the product being ordered using Magna Design specifications and terminology. All orders must be in writing.

TELEPHONE ORDERS:

All telephone orders must be confirmed with a written purchase order.

ACKNOWLEDGMENTS:

All orders when accepted will be acknowledged by mail indicating the terms and conditions by which the order was accepted and a description of the items being ordered. Orders will be completed and shipped in accordance with the information on the acknowledgment. If the acknowledged information is incorrect we must receive written instruction to change.

CHANGE ORDERS:

Order entry will take place upon receipt of an ENTERABLE purchase order from an authorized Magna Design dealer.

Once the order has been entered, no changes are allowed on MAGNA NOW! orders.

For orders not on the MAGNA NOW! shipping program, order changes will be subject to a minimum \$25 processing fee. Actual change order charges may be higher depending on the status of the job at the time a change is made.

CANCELLATIONS:

A 15% minimum restocking charge will be applied on cancellations of standard products. Cancellations will not be accepted on special or custom products.

RETURNED GOODS:

Returned merchandise will not be accepted for return without twenty (20) days prior written notice and written Returned Goods Authorization (RGA) from Magna. Returned goods will be subject to a minimum 15% restocking and refurbishing charge in addition to shipping costs. (See Warranty policy for defective goods.)

LEAD TIMES:

To current accounts with approved credit, Magna FLEX *enterable* orders will be made available (in standard finishes) within 4 to 6 weeks. All orders are subject to current inventories. Leadtimes may vary according to factory volume.

To current accounts with approved credit, Magna NOW! *enterable* orders in standard finishes will be made available 10 *working days* after receipt of *enterable* order. *Working day* = Monday through Friday except factory holidays.

Day 1 (of 10) starts upon receipt of *enterable* order before 2:00 PM Pacific Time.

Will Call orders will be ready at 2:00 PM of Day 10.

Leadtimes may vary according to factory volume.

DELIVERY:

Orders will be delivered in accordance with the delivery dates indicated on the order acknowledgment and partial shipments may be made unless the order instructions indicate that an order must be shipped complete.

SHIPPING:

We reserve the right to use our own discretion in selecting routes and freight carriers. We will attempt to meet any special routing requirements that you may have but assume no liability for damages or costs incurred by our inability to do so.

FUEL SURCHARGE:

Effective June 1, 2007, we implemented a fuel surcharge. Please contact customer service or visit our website for current information.

STORAGE:

Storage charges will be charged on orders not accepted or picked up within five (5) days of acknowledged delivery dates unless we are notified thirty (30) days in advance. Storage will be charged at the rate of 2% for the first fifteen (15) days delay and 3% for each fifteen (15) day period thereafter.

FREIGHT CLAIMS:

Before signing a delivery receipt, make certain that goods are inspected for possible damage. If there is visual damage, record the extent of the damage on all copies of the bill of lading before signing. If there is no visual damage to goods that are cartoned or crated, we strongly suggest that the merchandise be unpacked and inspected immediately. If damages are discovered, save the packaging and contact the carrier immediately for inspection. Claims for damages should be filed with the delivering carrier and payment for the goods may not be withheld pending settlement of the carrier damage claims. Magna assumes no liability for freight damage or the workmanship or cost of repairs made by others without prior written authorization.

SPECIFICATIONS:

All published dimensions and weights are approximate and we assume no liability for errors or inaccuracies in product literature. We reserve the right to modify or change product design and/or delete product models without prior notice.

FINISHES:

We take great care in matching color and texture of materials in our product. However, it is impossible to guarantee exact matching in all cases.

Equations Standard Specifications

The Equations modular casegoods group is designed to offer maximum reconfiguration flexibility for the small office environment. Equations is a storage based system, shipped ready to assemble and provides a wide variety of configurations. Equations is offered in WoodPlus and ColorPlus laminates with matching 3mm PVC edges. Assemblies with P tops are handed. All other assemblies are non-handed and can be setup either Left or Right.

SPECIFICATION HIGHLIGHTS

All exposed laminate surfaces shall be Magna WoodPlus laminate. Standard finishes shall include WoodPlus wood grain patterns as described in the finishes section. Pedestals, lateral files, hutches, overheads and end support panels are also available in ColorPlus laminates.

Edge Bands

Standard tops and support panels are banded with 3mm PVC. Bottom edges of support panels are additionally banded with 3mm PVC to insure a structural base for leveling glides. Drawer fronts are banded with matching .020 PVC.

Tops

All Equations tops are 1-1/8" thick. The three ply balanced construction consists of a 45 LB industrial board core surfaced with WoodPlus laminate and a balancing backer sheet.

Maximum unsupported span for worksurfaces is 42".

Maximum span for TOP SUPPORT RAIL is 56".

Maximum span for MODESTY PANEL is 72".

Top edges

Worktop edges are 3mm woodgrained PVC and may be finished with your choice of the Smooth EQ edge, with the Reeded EQR edge or with the Neoclassic EQN edge on the worktops only.

Pedestals and Cabinets

In an component or layout, pedestal and / or cabinet configuration is already specified.

When ordered as a component part, pedestals are available in: BBF Box Box File with Lock; FF File File with Lock; BDL Box drawer, Door hinged Left, both Locked; BDR Box drawer, Door hinged Right, both Locked; DSL Door hinged Left with Lock; DSR Door hinged Right with Lock.

When ordered as a component part, cabinets are available as LF two lateral file drawers with Lock, AC Combo-A with Lock, BC Combo-B with Lock, DS Door storage, OS Open storage.

End Panels, Hutch Ends and Hutch Shelves

All end panels, hutch ends and hutch shelves are 1-1/8" thick, three ply balanced construction. Bottom edges of support panels are additionally banded with 3mm PVC to insure a structural base for leveling glides. End panels, and hutch ends are constructed with vertical grain patterns. All Equations end panels are supplied with support brackets.

Drawer Fronts, Doors, Modesty Panels, Back and Side Panels

All drawer fronts, doors, pedestal and cabinet case sides and back, modesty panels and hutch backs are 3/4" thick, three ply balanced construction.

Modesty panels are available with horizontal grain patterns which are parallel to the work surface or with vertical grain patterns on Modesty Panels up to 60" long. Desk and credenza modesty panels are typically constructed with horizontal grain.

Drawer fronts, pedestal and cabinet sides and backs are constructed with vertical grain patterns.

Drawers

All drawers are constructed as a five sided box with separate attached drawer faces. This technique ensures superior structural integrity and easy drawer front replacement. Standard drawers are of miter fold construction with a black vinyl finish and matching high density harBBFoard bottom. Applied drawer pull is screw fastened for maximum strength.

Filing Capabilities

All file drawers are provided with file holders configured for letter front to back and legal side to side filing. Lateral file drawers are provided with file holders configured for side to side filing. Hardware is finished in a matte black.

Drawer Suspension

Pedestal box drawers utilize three quarter extension ball bearing, 75 LB rated slides.

Lateral File drawers and Pedestal File drawers utilize full extension progressive action ball bearing, 150 LB slides. Lateral Files are equipped with an anti-tilt device for safety.

The EQ-PM-BF mobile pedestals Box and File drawers utilize full extension progressive action ball bearing 100 LB slides.

Locks

Locks are included on all drawer pedestals and lateral files. Combo-A and Combo-B include lock for the lateral file and file drawers. The two box drawers in Combo-A and Combo-B do not lock.

Removable lock cylinders provide for keying alike or re-keying in the field. An optional Cylinder change tool is available to re-key locks, please contact Customer Service.

Equations Standard Specifications

Hutches

Equations hutches are available as open, flipper door, hinged doors, shaped hinged doors, glass doors with aluminum or glass doors with WoodPlus frames. All include a valance. Worklights can be mounted below fixed shelf for additional lighting. All hutches are pre-drilled for wire dividers which are available upon request.

Flipper doors have horizontal grain, all other doors have vertical grain.

Hutches can only be installed on worksurfaces with full depth support, i.e. 24" deep tops and support components or 30" deep tops and support components.

Hinged Door pull is screw fastened for maximum strength. Pull not available on glass doors.

Adjustable Glides

All free standing components are equipped with threaded stem adjustable glides. Glides are set in threaded inserts fitted in a PVC edge band for structural integrity.

Wire Management

Grommets are included on corner tops. Finish is satin black.

Grommets are located so that Rectangular, Corner and Radius End tops are non-handed. P tops are handed with or without a grommet. Bow front tops are handed when a grommet is added.

Worklight

All worklights are UL labeled and have a built in diffuser. Finish is black.

Finishes

Equations components are available in WoodPlus finishes with a matching WPE WoodPlus wood grained PVC edge. Pedestals, cabinets and end support panels are also available in ColorPlus laminates.

Magna WoodPlus laminate finish consists of a unique combination of wood products and resins thermofused under high temperature and pressure into a single, wood grained or solid color structural panel. Work surfaces are WoodPlus high pressure. Panel edges are finished in matching PVC.

Cleaning and Care

WoodPlus / ColorPlus may be cleaned with mild cleaning agents that contain no abrasives, bleach or bleach substitutes. Under no circumstances can acetone or polish remover be used to clean any of the surfaces. Using it will void the warranty on the product and can do considerable damage to the surface.

Specifications subject to change without notice.

EQUATIONS² Product Specifications

Product Overview

Equations² products consist of components and accessories in a variety of existing and new shapes and layouts.

Equations² is a storage based system, shipped ready to assemble and provides a wide variety of configurations.

Configurations with P tops and Comma top are handed. Bow tops with a grommet are handed.

All other components are non-handed and can be setup either Left or Right.

SPECIFICATION HIGHLIGHTS

All exposed surfaces shall be Magna WoodPlus² / ColorPlus² laminates. Standard finishes are described in the finishes section.

Equations² Components and Equations² Shapes Components

Tops

All WoodPlus² tops are 1-1/8" thick with a formed edge. WoodPlus² top construction consists of a 48 LB MDF core surfaced with rigid thermoformed polymer-based decorative composite sheet and a balancing backer sheet.

Top Grain Direction

WoodPlus² tops are standard with grain running the length of the top.

Edges

WoodPlus² / ColorPlus² horizontal and vertical surfaces come with rounded, soft edges that are a seamless and integrated part of the surface. A softer 'USER EDGE' and a 'JOINT EDGE' are integrated on tops.

Pedestals and Cabinets

In an component or layout, pedestal and / or cabinet configuration is already specified.

When ordered as a component part, pedestals are available in: BBF Box Box File with Lock; FF File File with Lock; BDL Box drawer, Door hinged Left, both Locked; BDR Box drawer, Door hinged Right, both Locked; DSL Door hinged Left with Lock; DSR Door hinged Right with Lock.

EQUATIONS² Product Specifications

When ordered as a component part, cabinets are available as LF two lateral file drawers with Lock, AC Combo-A with Lock, BC Combo-B with Lock, DS Door storage, OS Open storage.

End Panels, Hutch Ends and Hutch Shelves

All end panels, hutch ends and hutch shelves are 1-1/8" thick, three ply balanced construction. Bottom edges of support panels are additionally banded with 3mm PVC to insure a structural base for leveling glides. End panels, and hutch ends are constructed with vertical grain patterns. End panels are supplied with support brackets.

Drawer Fronts, Doors, Modesty Panels, Back and Side Panels

All drawer fronts, doors, pedestal and cabinet case sides and back, modesty panels and hutch backs are 3/4" thick, three ply balanced construction.

Modesty panels are available with horizontal grain patterns which are parallel to the work surface or with vertical grain patterns on Modesty Panels up to 60" long. Desk and credenza modesty panels are typically constructed with horizontal grain.

Drawer fronts, pedestal and cabinet sides and backs are constructed with vertical grain patterns.

Drawers

All drawers are constructed as a five sided box with separate attached drawer faces. This technique ensures superior structural integrity and easy drawer front replacement. Standard drawers are of miter fold construction with a black vinyl finish and matching high density hardboard bottom. Applied drawer pull is screw fastened for maximum strength.

Filing Capabilities

All file drawers are provided with file holders configured for letter front to back and legal side to side filing. Lateral file drawers are provided with file holders configured for side to side filing. Hardware is finished in a matte black.

Drawer Suspension

Pedestal box drawers utilize three quarter extension ball bearing, 75 LB rated slides.

Lateral File drawers and Pedestal File drawers utilize full extension progressive action ball bearing, 150 LB slides. Lateral Files are equipped with an anti-tilt device for safety.

The EQ-PM-BF mobile pedestals Box and File drawers utilize full extension progressive action ball bearing 100 LB slides.

Locks

Locks are included on all drawer pedestals and lateral files. Combo-A and Combo-B include lock for the lateral file and file drawers. The two box drawers in Combo-A and Combo-B do not lock.

Removable lock cylinders provide for keying alike or re-keying in the field. An optional Cylinder change tool is available to re-key locks, please contact Customer Service.

Hutches

Equations² hutches are available with hinged doors, shaped hinged doors or glass doors with WoodPlus² frames. Worklights can be mounted below fixed shelf for additional lighting. All hutches are pre-drilled for wire dividers. All Hutches include a valance.

All doors have vertical grain and are full overlay with a rounded edge profile.

Hutches can only be installed on worksurfaces with full depth support, i.e. 24" deep tops and support components or 30" deep tops and support components. Hinged Door pull is screw fastened for maximum strength.

Adjustable Glides

All free standing components are equipped with threaded stem adjustable glides. Glides are set in threaded inserts fitted in a PVC edge band for structural integrity.

Locks

Locks are standard on all lateral file and file drawers. Locks are available on hinged doors as an option.

Removable lock cylinders provide for keying alike or re-keying in the field.

Wire Management

Optional wire managers are available. Finish is satin black.

Worklight

All worklights are UL labeled and have a built in diffuser. Finish is black.

Finishes

WoodPlus² / ColorPlus² components are manufactured using thermoformed polymer based, decorative composite sheets in wood grain, speckle and solid patterns. The result is a seamless component with formed edges and exceptional wear and appearance characteristics.

Cleaning and Care

WoodPlus² / ColorPlus² may be cleaned with mild cleaning agents that contain no bleach or bleach substitutes. Under no circumstances can acetone or polish remover be used to clean any of the surfaces. Using it will void the warranty on the product and can do considerable damage to the surface.

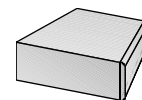







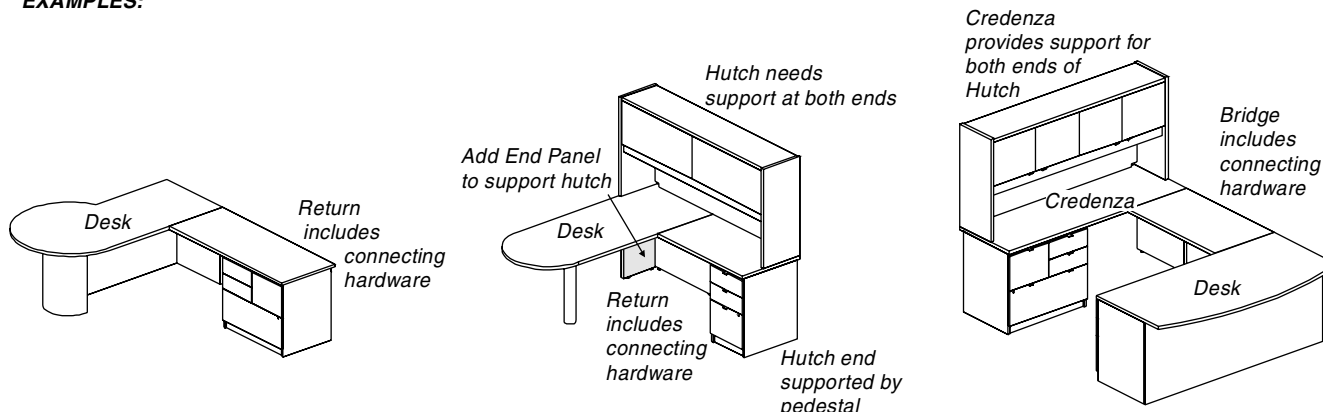



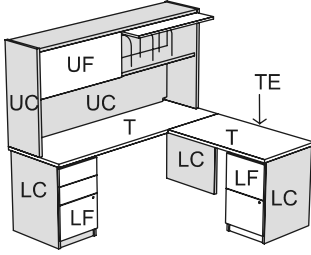





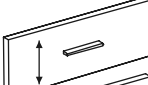
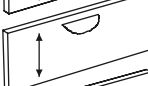
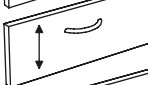
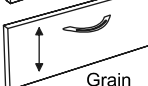
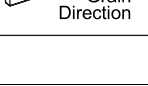





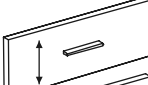
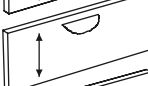
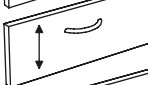
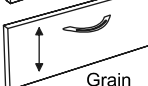
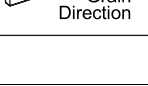

How to layout Equations

- STEP 1:** Layout Desks, Bridges, Returns, Credenzas, Overheads, Storage as needed using Equations components and/or component parts
- STEP 2:** Support both ends of every Hutch, Both ends of bridge top connect to adjacent desks, credenzas or corners. One end of return top connects to the adjacent desk, credenza or corner.

EXAMPLES:

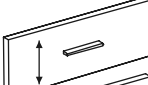
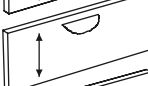
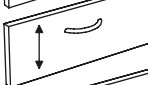
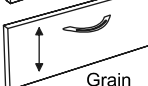
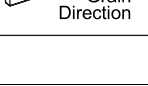

- STEP 3:** Answer the Specification questions for all components

<p>Please Specify:</p> <p><u>for Worktops</u> T - Worktop finish - Top Edge profile TE - Top Edge finish</p> <p><u>for Lowers</u> LC - Cabinet case, Modesty Panels, End Panels finish LF - lower face finish - Pull number</p> <p><u>for Hutches/Overheads</u> UC - Top, ends and back finish UF - upper doors, tower doors finish - Pull number</p> 	<p>Available Finishes:</p> <p>FOR ALL SURFACES</p> <table border="0"> <tr> <td><u>WoodPlus</u></td> <td><u>WoodPlus XTRA*</u></td> </tr> <tr> <td>WP41 Natural Maple</td> <td>WP05 Rift Oak</td> </tr> <tr> <td>WP81 Fusion Maple</td> <td>WP35 Golden Cherry (2)</td> </tr> <tr> <td>WP04 Solar Oak</td> <td>WP75 Chestnut</td> </tr> <tr> <td>WP45 Anigre</td> <td>WP33 Blossom Cherry</td> </tr> <tr> <td>WP61 Pear</td> <td>WP37 Mocha Cherry (2)</td> </tr> <tr> <td>WP31 Medium Cherry</td> <td>WP67 Chocolate Pear (2)</td> </tr> <tr> <td>WP71 Dark Cherry</td> <td>WP15 Midnight (1)</td> </tr> <tr> <td>WP73 Cognac</td> <td></td> </tr> <tr> <td>WP48 Sipping Seattle Java</td> <td>*XTRA Add \$600 per finish per order</td> </tr> <tr> <td>WP23 Cordovan</td> <td></td> </tr> </table> <p>(1) use complimentary CP-76 Espresso 3mm PVC edge</p> <p>(2) matching PVC edge is not currently available</p> <p>FOR ANY SURFACE EXCEPT WORKTOPS</p> <table border="0"> <tr> <td>CP88 Black</td> <td>P1 Black</td> </tr> <tr> <td>CP76 Espresso</td> <td>P8 Silver</td> </tr> <tr> <td>CP98 Slate</td> <td></td> </tr> </table> <p>COLUMN SUPPORTS</p>	<u>WoodPlus</u>	<u>WoodPlus XTRA*</u>	WP41 Natural Maple	WP05 Rift Oak	WP81 Fusion Maple	WP35 Golden Cherry (2)	WP04 Solar Oak	WP75 Chestnut	WP45 Anigre	WP33 Blossom Cherry	WP61 Pear	WP37 Mocha Cherry (2)	WP31 Medium Cherry	WP67 Chocolate Pear (2)	WP71 Dark Cherry	WP15 Midnight (1)	WP73 Cognac		WP48 Sipping Seattle Java	*XTRA Add \$600 per finish per order	WP23 Cordovan		CP88 Black	P1 Black	CP76 Espresso	P8 Silver	CP98 Slate		<p>Worktop Edge Profiles:</p> <p>WoodPlus 3mm PVC edge for worktops</p> <table border="0"> <tr> <td></td> <td></td> <td></td> </tr> <tr> <td>Smooth</td> <td>Reeded</td> <td>NeoClassic</td> </tr> </table> <p>Standard wood 3mm edge for worktops - add \$100 List for each worktop</p> <table border="0"> <tr> <td></td> <td></td> <td></td> </tr> <tr> <td>Smooth</td> <td>Reeded</td> <td>NeoClassic</td> </tr> </table> <p>WoodPlus PVC edge for hutches, end panels, flipper doors is always EQS (smooth).</p> <p>Pull Style Numbers:</p> <table border="0"> <tr> <td></td> <td>#10 Black Chrome</td> </tr> <tr> <td></td> <td>#12 Black</td> </tr> <tr> <td></td> <td>#13 Satin Chrome</td> </tr> <tr> <td></td> <td>#14 Black</td> </tr> <tr> <td></td> <td>#15 Satin Chrome</td> </tr> <tr> <td></td> <td>#18 Black</td> </tr> <tr> <td></td> <td>#19 Satin Chrome</td> </tr> </table> <p>#14, 15, 18 & 19 are ADA compliant</p> <p>Grain Direction</p>				Smooth	Reeded	NeoClassic				Smooth	Reeded	NeoClassic		#10 Black Chrome		#12 Black		#13 Satin Chrome		#14 Black		#15 Satin Chrome		#18 Black		#19 Satin Chrome
<u>WoodPlus</u>	<u>WoodPlus XTRA*</u>																																																							
WP41 Natural Maple	WP05 Rift Oak																																																							
WP81 Fusion Maple	WP35 Golden Cherry (2)																																																							
WP04 Solar Oak	WP75 Chestnut																																																							
WP45 Anigre	WP33 Blossom Cherry																																																							
WP61 Pear	WP37 Mocha Cherry (2)																																																							
WP31 Medium Cherry	WP67 Chocolate Pear (2)																																																							
WP71 Dark Cherry	WP15 Midnight (1)																																																							
WP73 Cognac																																																								
WP48 Sipping Seattle Java	*XTRA Add \$600 per finish per order																																																							
WP23 Cordovan																																																								
CP88 Black	P1 Black																																																							
CP76 Espresso	P8 Silver																																																							
CP98 Slate																																																								
																																																								
Smooth	Reeded	NeoClassic																																																						
																																																								
Smooth	Reeded	NeoClassic																																																						
	#10 Black Chrome																																																							
	#12 Black																																																							
	#13 Satin Chrome																																																							
	#14 Black																																																							
	#15 Satin Chrome																																																							
	#18 Black																																																							
	#19 Satin Chrome																																																							

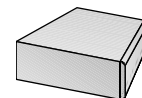

How to layout Equations

Equations Standard available grommet locations

Grommets NOT available over Pedestal or Cabinet

Rectangular credenza worktops

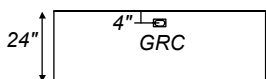
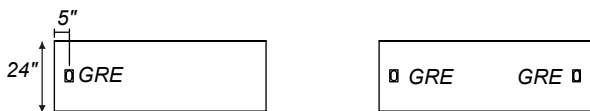

Shark desk worktops



P top desk worktops

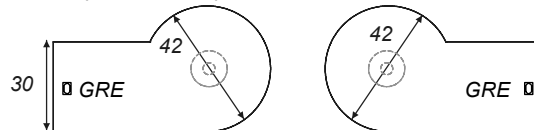

Rectangular desk worktops

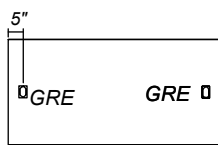
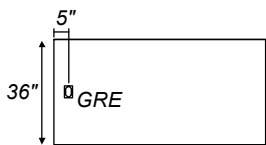
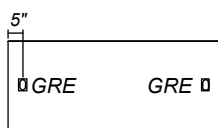

Corner extension worktop

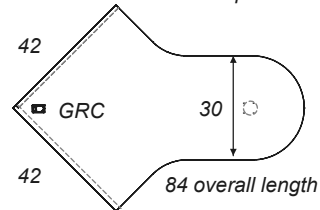

Bow front desk worktops

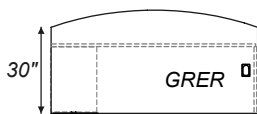
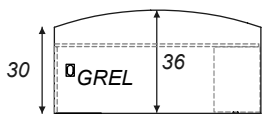

Angled Radius end worktop

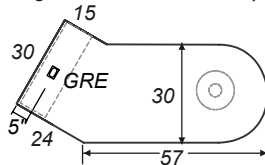

Radius end desk worktops



Keyhole desk worktops



Corner worktop, always includes GRC

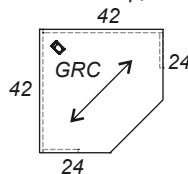

Tapered Leg Option

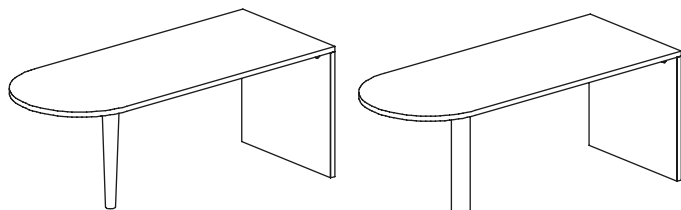

with Tapered Leg (optional)
To be connected to bridge or return

with 4" column base (default)
To be connected to bridge or return

Column Base Plate Option

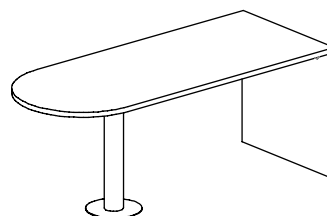

with Column Base Plate Option
Unit is to be freestanding desk

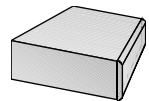

EQUATIONS - Configuration Examples

Equations WoodPlus Configurations

Worktop Edge Profiles:

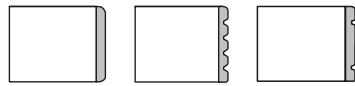

Smooth Reeded NeoClassic

PVC: WPES WPER WPEN

Wood: SWES SWER SWEN

Hutches, ends, flipper doors use Smooth PVC edge WPES, or Smooth Wood edge SWES.

WoodPlus is a unique combination of wood products and resins thermofused under high temperature and pressure. Worktops are WoodPlus high pressure.

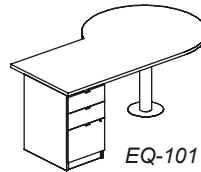

EQ-101

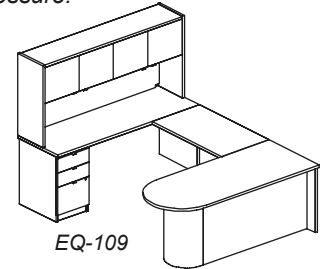

EQ-109

MAGNA NOW! 10 day Shipping*

Equations Standard

Equations Configuration EQ-101

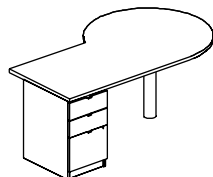

EQ-101

EQ-D-P-427229-BBF-C4-L	Desk, P top with Box Box File pedestal	1839
		Total Price 1839

Equations Configuration EQ-102

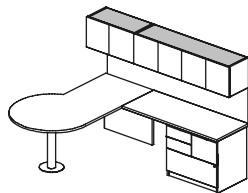

EQ-102

EQ-D-P-427229-C4-R	Desk, P top	1310
EQ-R-TT-246029-AC	Return with Combo-A cabinet	1500
EQ-OW-156016-HDT	Overhead, wall mounted, hinged doors	1049
EQ-OW-153016-HDT	Overhead, wall mounted, hinged doors	685
FPW-45L-18H	Tackboard, wall mounted	222
FPW-45L-18H	Tackboard, wall mounted	222
		Total Price 4988

Equations Configuration EQ-103

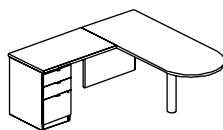

EQ-103

EQ-D-RE-307229-C4	Desk, Radius End top	1065
EQ-R-TT-244229-BBF	Return with Box Box File pedestal	1083
		Total Price 2148

Equations Configuration EQ-104

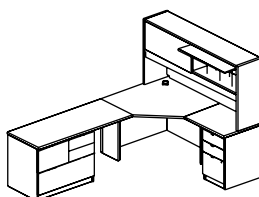

EQ-104

EQ-CNR-424229-24	Corner unit	1335
EQ-R-TT-243029-BBF	Return with Box Box File pedestal	1064
EQ-R-TT-246029-BC	Return with Combo-B cabinet	1500
EQ-H-TI-157235-FD	Hutch, flipper doors	1399
FPI-72L-35H	Tackboard for hutch	254
		Total Price 5552

*Equations Standard qualifies for MAGNA NOW! 10 day shipping program, except for models with glass doors.

You must specify MAGNA NOW! on your purchase order. For large orders, please check with Customer Service for leadtime.

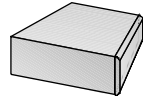

EQUATIONS - Configuration Examples

Equations Configuration EQ-105

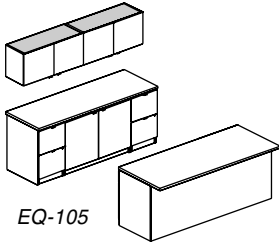

EQ-105

EQ-D-TT-367229-FF-MP-BBF	Desk with two pedestals and modesty panel	2212
EQ-CR-TT-247229-FF-DS-FF	Credenza, filled	2866
EQ-OW-153616-HDT	Overhead, wall mounted, hinged doors	740
EQ-OW-153616-HDT	Overhead, wall mounted, hinged doors	740
Total Price		6558

Equations Configuration EQ-106

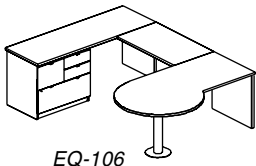

EQ-106

EQ-D-P-427229-C4-L	Desk, P top	1310
EQ-B-TT-244229	Bridge with hardware	286
EQ-CR-TT-247229-BC	Credenza with Combo-B cabinet	1717
Total Price		3313

Equations Configuration EQ-107

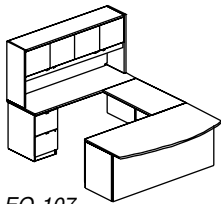

EQ-107

EQ-D-BO-367229-BBF-MP	Desk, Bow front, modesty panel, Box Box File pedestal	1769
EQ-B-TT-244229	Bridge with hardware	286
EQ-CR-TT-247229-FF	Credenza with File File pedestal	1432
EQ-H-TI-157242-HD	Hutch, hinged doors	1442
FPI-72-42	Tackboard for hutch	254
Total Price		5183

Equations Configuration EQ-108

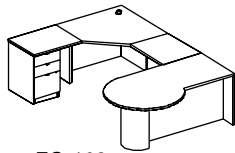

EQ-108

EQ-D-P-427229-HC-MP-L	Desk, P top, half cylinder and modesty panel	1932
EQ-B-TT-243029	Bridge with hardware	267
EQ-CNR-424229-24	Corner unit	1335
EQ-R-TT-243029-BBF	Return with Box Box File pedestal	1064
Total Price		4598

Equations Configuration EQ-109

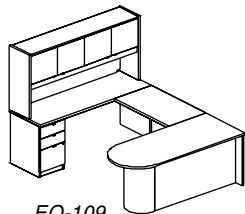

EQ-109

EQ-D-RE-307229-HC-MP	Desk, Radius End with half cylinder, modesty panel	1752
EQ-B-TT-244229	Bridge with hardware	286
EQ-CR-TT-247229-BBF	Credenza with Box Box File pedestal	1432
EQ-H-TI-157235-HD	Hutch, hinged doors	1399
FPI-72-35	Tackboard for hutch	254
Total Price		5123

*Equations Standard qualifies for MAGNA NOW! 10 day shipping program, except for models with glass doors. You must specify MAGNA NOW! on your purchase order. For large orders, please check with Customer Service for leadtime.

EQUATIONS - Component Overview

Radius End Desks

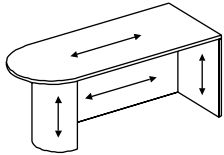

"RE desk, single pedestal" on page 14

Angled Radius End Desk

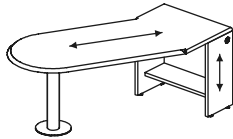

"Angled Radius End Desk" on page 15

Keyhole Desks

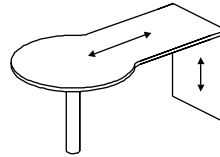

"Keyhole Desk" on page 15

P top Desks

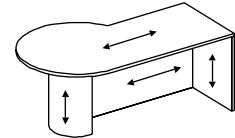

"P Top Desk, single pedestal" on page 16

Shark Desks

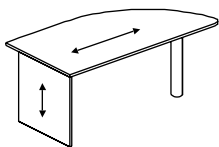

"Shark Desk" on page 17

Bow Front Desks

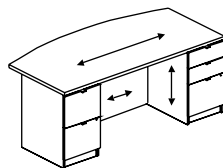

"Bow Front Desk" on page 18

Rectangular Desks

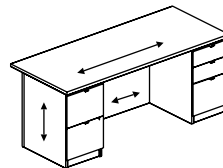

"Rectangular Desk" on page 18

Corner Component

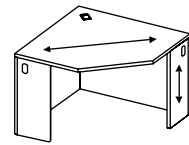

"Corner Component" on page 19

Returns with Pedestal

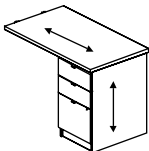

"Return with Single Pedestal" on page 20

Returns with Combo-A

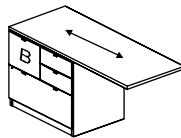

"Return with Combo Cabinet or Lateral File" on page 21

Bridge Tops

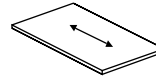

"Bridge" on page 22

Filled credenza

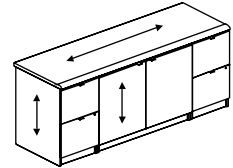

"Credenzas, stand alone, filled with pedestals and door storage" on page 24

Hutches

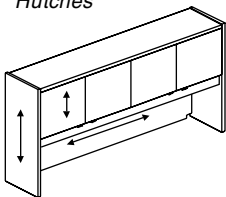

"Hutches at Standard Height -35 - matches towers at 65 high" on page 26

Combination cabinet

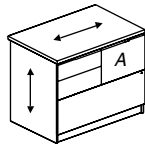

"Pedestals, Lateral File and Combo Components with worktop" on page 33

Lateral File and Hutch

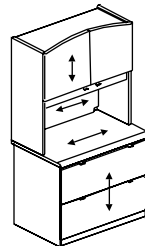

"Lateral File drawers with hutch storage above" on page 35

Reception Desk
Bow Front Counter

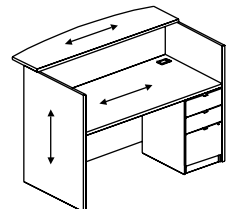

"Reception Desks" on page 39

EQUATIONS - Component Pricing

Description	Model	Dimensions			Wgt	List Prices <small>WoodPlus Edge</small>
		Deep	Long	High		



RE desk, single pedestal

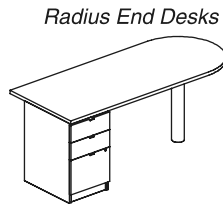

Radius End Desks

Column,	EQ-D-RE-306029-BBF-C4	30	60	29	147	1603
pedestal	EQ-D-RE-306629-BBF-C4	30	66	29	153	1638
	EQ-D-RE-307229-BBF-C4	30	72	29	159	1662

Radius End desk has column support and 24" deep Box Box File pedestal with lock.

Option	OPTION-TAPERED-LEG					78
---------------	---------------------------	--	--	--	--	-----------

To order the Tapered Leg in place of the 4 inch column add ' -TL' to the model number.

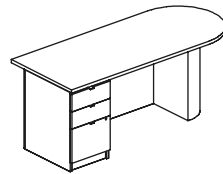

Modesty	EQ-D-RE-306029-BBF-MP-HC	30	60	29	173	2290
Panel,	EQ-D-RE-306629-BBF-MP-HC	30	66	29	183	2326
pedestal	EQ-D-RE-307229-BBF-MP-HC	30	72	29	192	2349

Radius End desk has modesty panel, half cylinder and 24" deep Box Box File pedestal with lock.

Please specify pull number for drawers.

RE desk, no pedestal

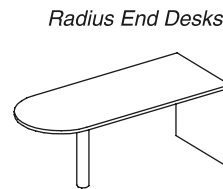

Radius End Desks

Column	EQ-D-RE-306029-C4	30	60	29	95	1006
	EQ-D-RE-306629-C4	30	66	29	101	1041
	EQ-D-RE-307229-C4	30	72	29	107	1065

Radius End desk has column support.

Option	OPTION-COLUMN-BASE-PLATE	12	12	0	8	68
---------------	---------------------------------	----	----	---	---	-----------

	OPTION-TAPERED-LEG					78
--	---------------------------	--	--	--	--	-----------

	OPTION-GRE					48
--	-------------------	--	--	--	--	-----------

This 12" diameter plate attaches to the bottom of the 4" column (not to the Tapered Leg). Required when the desk with column is freestanding (i.e. no bridge or return is connected to it). To order add ' -CBP' after the model number.

To order the Tapered Leg in place of the 4 inch column add ' -TL' to the model number. With the Tapered Leg, the desk must be attached to return or bridge top.

To order a worktop grommet at the ' flat' end of the desk add ' -GRE' to the model number .

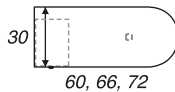
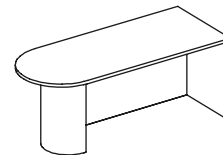

Modesty Panel	EQ-D-RE-306029-MP-HC	30	60	29	121	1693
	EQ-D-RE-306629-MP-HC	30	66	29	131	1729
	EQ-D-RE-307229-MP-HC	30	72	29	140	1752

Radius End desk has modesty panel and half cylinder.

Option	OPTION-GRE					48
---------------	-------------------	--	--	--	--	-----------

To order a worktop grommet at the ' flat' end of the desk add ' -GRE' to the model number .

***Equations Standard qualifies for MAGNA NOW! 10 day shipping program, except for models with glass doors.**

You must specify MAGNA NOW! on your purchase order. For large orders, please check with Customer Service for leadtime.

EQUATIONS - Component Pricing

Description	Model	Dimensions			Wgt	List Prices <small>WoodPlus Edge</small>
		Deep	Long	High		

Angled Radius End Desk

Angled Radius End Desk

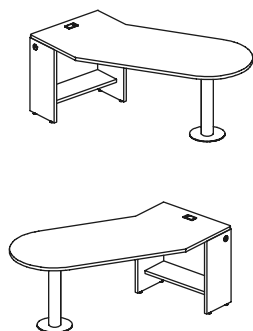

Angled Radius	EQ-D-ARE-307629-C4-L	30	76	29	185	1710
End	EQ-D-ARE-307629-C4-R	30	76	29	185	1710

Allows use of 24" return top, or may be freestanding.

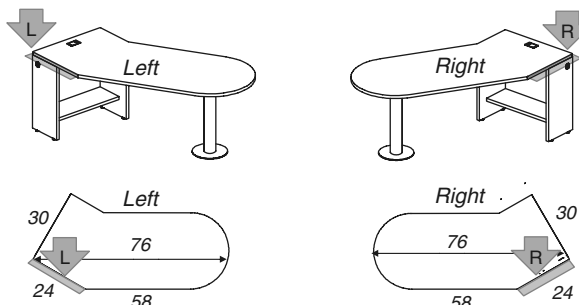

Keyhole Desk

Keyhole Desks

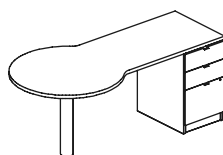

Column,	EQ-D-KH-366029-BBF-C4	36	60	29	141	1781
Pedestal	EQ-D-KH-366629-BBF-C4	36	66	29	147	1815
	EQ-D-KH-367229-BBF-C4	36	72	29	153	1839

Keyhole desk has Box Box File pedestal with lock. Specify pull.
Please specify pull number for drawers.

Option	OPTION-TAPERED-LEG	78
---------------	---------------------------	-----------

To order the Tapered Leg in place of the 4 inch column add ' -TL' to the model number.

Keyhole top desk, no pedestal

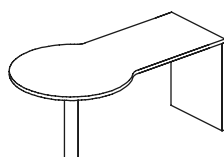

Column	EQ-D-KH-366029-C4	36	60	29	83	1173
	EQ-D-KH-366629-C4	36	66	29	89	1207
	EQ-D-KH-367229-C4	36	72	29	95	1231

Keyhole desk with column and end panel.

OPTION-COLUMN-BASE-PLATE	12	12	0	8	68
OPTION-TAPERED-LEG				8	78
OPTION-GRE				0	48

This 12" diameter plate attaches to the bottom of the 4" column (not to the Tapered Leg).
Required when this model is freestanding (i.e. no bridge or return is connected to it).
To order add ' -CBP' after the model number.

To order the Tapered Leg in place of the 4 inch column add ' -TL' to the model number.
With the Tapered Leg, the desk must be attached to return or bridge top.

To order a worktop grommet at the ' flat' end of the desk add ' -GRE' to the model number .

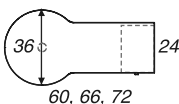

60, 66, 72

***Equations Standard qualifies for MAGNA NOW! 10 day shipping program, except for models with glass doors.**

You must specify MAGNA NOW! on your purchase order. For large orders, please check with Customer Service for leadtime.

EQUATIONS - Component Pricing

Description	Model	Dimensions			Wgt	List Prices <small>WoodPlus Edge</small>
		Deep	Long	High		



P Top Desk, single pedestal

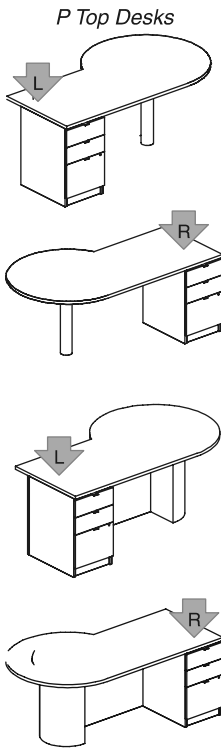

Pedestal	EQ-D-P-426629-BBF-C4-L	42	66	29	177	1815
Left	EQ-D-P-427229-BBF-C4-L	42	72	29	185	1839
P top desk has column support and 24" deep Box Box File pedestal with lock. Specify pull. Pedestal is to the LEFT of the user. Please specify pull number for drawers.						
Pedestal	EQ-D-P-426629-BBF-C4-R	42	66	29	177	1815
Right	EQ-D-P-427229-BBF-C4-R	42	72	29	185	1839
P top desk has column support and 24" deep Box Box File pedestal with lock. Specify pull. Pedestal is to the RIGHT of the user. Please specify pull number for drawers.						
Options	OPTION-TAPERED-LEG				8	78
To order the Tapered Leg in place of the 4 inch column add ' -TL' to the model number.						
Pedestal	EQ-D-P-426629-BBF-MP-HC-L	42	66	29	222	2506
Left	EQ-D-P-427229-BBF-MP-HC-L	42	72	29	234	2529
P top desk has modesty panel, half cylinder and 24" deep Box Box File pedestal with lock. Specify pull. Pedestal is to the LEFT of the user. Please specify pull number for drawers.						
Pedestal	EQ-D-P-426629-BBF-MP-HC-R	42	66	29	222	2506
Right	EQ-D-P-427229-BBF-MP-HC-R	42	72	29	234	2529
P top desk has modesty panel, half cylinder and 24" deep Box Box File pedestal with lock. Specify pull. Pedestal is to the RIGHT of the user. Please specify pull number for drawers.						

P top desk, no pedestal

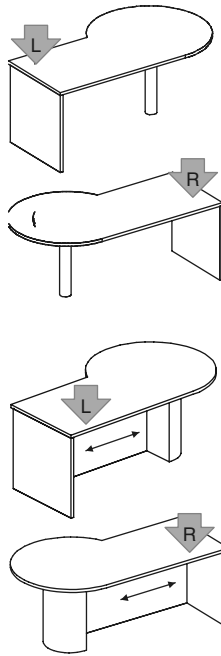

Return Left, with column	EQ-D-P-426629-C4-L	42	66	29	133	1286
	EQ-D-P-427229-C4-L	42	72	29	141	1310
P top desk has column support. Connecting top is to the LEFT of the user. This P top desk must be attached to a bridge or return top for configuration stability.						
Return Right, with column	EQ-D-P-426629-C4-R	42	66	29	133	1286
	EQ-D-P-427229-C4-R	42	72	29	141	1310
P top desk has column support. Connecting top is to the RIGHT of the user. This P top desk must be attached to a bridge or return top for configuration stability.						
Return Left, with half cylinder	EQ-D-P-426629-MP-HC-L	42	66	29	170	1909
	EQ-D-P-427229-MP-HC-L	42	72	29	182	1932
P top desk has modesty panel and half cylinder. Connecting top is to the LEFT of the user.						
Return Right, with half cylinder	EQ-D-P-426629-MP-HC-R	42	66	29	170	1909
	EQ-D-P-427229-MP-HC-R	42	72	29	182	1932
P top desk has modesty panel and half cylinder. Connecting top is to the RIGHT of the user.						
Option	OPTION-GRE					48
To order a worktop grommet at the ' flat' end of the desk add ' -GRE' to the model number .						

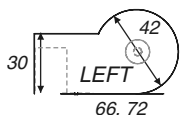

***Equations Standard qualifies for MAGNA NOW! 10 day shipping program, except for models with glass doors.**

You must specify MAGNA NOW! on your purchase order. For large orders, please check with Customer Service for leadtime.

EQUATIONS - Component Pricing

Description	Model	Dimensions			Wgt	List Prices WoodPlus Edge
		Deep	Long	High		



Shark Desk

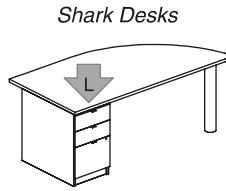

Shark Desks

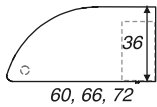
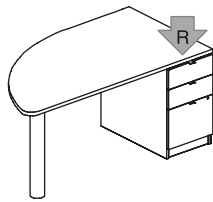

Pedestal	EQ-D-SH-366029-BBF-C4-L	36	60	29	141	1805
Left	EQ-D-SH-366629-BBF-C4-L	36	66	29	147	1840
	EQ-D-SH-367229-BBF-C4-L	36	72	29	153	1863

Shark desk has Box Box File pedestal with lock. Specify pull.
Pedestal is to the LEFT of the user.

Pedestal	EQ-D-SH-366029-BBF-C4-R	36	60	29	141	1805
Right	EQ-D-SH-366629-BBF-C4-R	36	66	29	147	1840
	EQ-D-SH-367229-BBF-C4-R	36	72	29	153	1863

Shark desk has Box Box File pedestal with lock. Specify pull.
Pedestal is to the RIGHT of the user.

Option	OPTION-TAPERED-LEG					78
---------------	---------------------------	--	--	--	--	-----------

Tapered Leg is available in place of the 4.5 inch column.

Shark desk, no pedestal

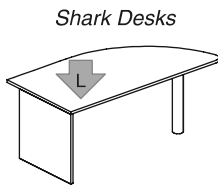

Shark Desks

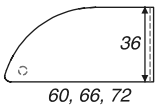
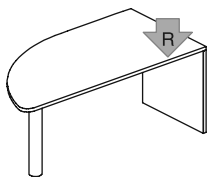

Return Left	EQ-D-SH-366029-C4-L	36	60	29	89	1208
	EQ-D-SH-366629-C4-L	36	66	29	95	1243
	EQ-D-SH-367229-C4-L	36	72	29	101	1266

Connecting top is to the LEFT of the user.

Return Right	EQ-D-SH-366029-C4-R	36	60	29	89	1208
	EQ-D-SH-366629-C4-R	36	66	29	95	1243
	EQ-D-SH-367229-C4-R	36	72	29	101	1266

Connecting top is to the RIGHT of the user.

Option	OPTION-COLUMN-BASE-PLATE	12	12		8	68
	OPTION-TAPERED-LEG					78
	OPTION-GRE					48

This 12" diameter plate attaches to the bottom of the 4" column (not to the Tapered Leg).
Required when this desk is freestanding (i.e. no bridge or return is connected to it).
To order add '-CBP' after the model number.

To order the Tapered Leg in place of the 4 inch column add '-TL' to the model number.
With the Tapered Leg, the desk must be attached to return or bridge top.

To order a worktop grommet at the 'flat' end of the desk add '-GRE' to the model number.

*Equations Standard qualifies for MAGNA NOW! 10 day shipping program, except for models with glass doors.

You must specify MAGNA NOW! on your purchase order. For large orders, please check with Customer Service for leadtime.

EQUATIONS - Component Pricing

<i>Description</i>	<i>Model</i>	<i>Dimensions</i>			<i>Wgt</i>	<i>List Prices</i>
		<i>Deep</i>	<i>Long</i>	<i>High</i>		<small>WoodPlus Edge</small>



Bow Front Desk

Bow Front Desks

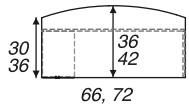
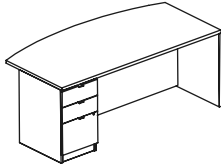

36 deep	EQ-D-BO-366629-BBF-MP	36	66	29	225	1745
	EQ-D-BO-367229-BBF-MP	36	72	29	234	1769

Bow front desk 36 deep by 72 long with modesty panel.
24 deep Box Box File pedestal with lock. Specify pull.
May be setup with pedestal to either the Left or Right.

42 deep	EQ-D-BO-426629-BBF-MP	42	66	29	246	1856
	EQ-D-BO-427229-BBF-MP	42	72	29	257	1879

Bow front desk 42 deep by 72 long with modesty panel.
30 deep Box Box File pedestal with lock. Specify pull.
May be setup with pedestal to either the Left or Right.

Option

To order a worktop grommet to the LEFT of the user, add ' -GREL' to the model number .
To order a worktop grommet to the RIGHT of the user, add ' -GRER' to the model number .
Adding either a GREL or GRER grommet makes the bow front top handed.

Bow front desk, double pedestals

Bow Front Desks

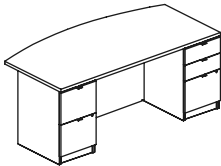

36 deep	EQ-D-BO-366629-FF-MP-BBF	36	66	29	283	2353
	EQ-D-BO-367229-FF-MP-BBF	36	72	29	292	2377

Bow front desk 36 deep with modesty panel.
24 deep Box Box File pedestal with lock and 24 deep File File pedestal with lock. Specify pull.

42 deep	EQ-D-BO-426629-FF-MP-BBF	42	66	29	298	2453
	EQ-D-BO-427229-FF-MP-BBF	42	72	29	309	2476

Bow front desk 42 deep with modesty panel.
30 deep Box Box File pedestal with lock and 30 deep File File pedestal with lock. Specify pull.

Rectangular Desk

Rectangular Desks with Modesty Panel

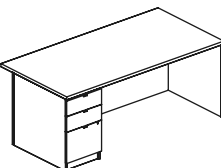
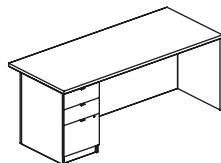

30 deep	EQ-D-TT-306029-BBF-MP	30	60	29	200	1531
	EQ-D-TT-306629-BBF-MP	30	66	29	210	1545
	EQ-D-TT-307229-BBF-MP	30	72	29	219	1560

Rectangular desk with modesty panel. 24 deep Box Box file pedestal with lock. Specify pull.
May be setup with pedestal to either the Left or Right.

36 deep	EQ-D-TT-367229-BBF-MP	36	72	29	240	1615
----------------	------------------------------	----	----	----	-----	-------------

Rectangular desk with modesty panel. 30 deep Box Box file pedestal with lock. Specify pull.
May be setup with pedestal to either the Left or Right.

Option

OPTION-GRE	48
-------------------	-----------

Add ' -GRE' to the end of the model number to order a worktop grommet at one end of the desk, centered front to back.

***Equations Standard qualifies for MAGNA NOW! 10 day shipping program, except for models with glass doors.**

You must specify MAGNA NOW! on your purchase order. For large orders, please check with Customer Service for leadtime.

EQUATIONS - Component Pricing

Description	Model	Dimensions			Wgt	List Prices WoodPlus Edge
		Deep	Long	High		

Rectangular desk, double pedestals

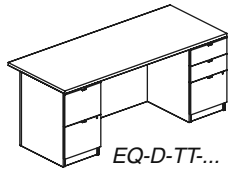

30 deep	EQ-D-TT-306029-FF-MP-BBF	30	60	29	258	2139
	EQ-D-TT-306629-FF-MP-BBF	30	66	29	268	2153
	EQ-D-TT-307229-FF-MP-BBF	30	72	29	277	2168

Rectangular desk with modesty panel.

24 deep Box Box file pedestal with lock and 24 deep File File pedestal with lock. Specify pull.

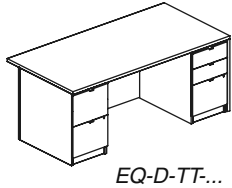

36 deep	EQ-D-TT-367229-FF-MP-BBF	36	72	29	292	2212
----------------	---------------------------------	----	----	----	-----	-------------

Rectangular desk with modesty panel.

30 deep Box Box file pedestal with lock and 30 deep File File pedestal with lock. Specify pull.



Corner Extension Desk

Corner Extension Desk

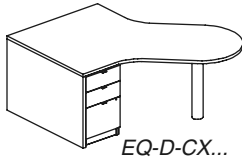

Corner extension desk with BBF pedestal	EQ-D-CX-428429-BBF-C4	42	84	29	254	2434
--	------------------------------	----	----	----	-----	-------------

Full corner extension desk with column support.

24" deep Box Box File pedestal with lock. Specify pull.

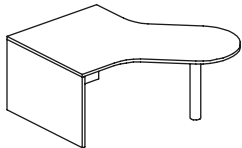

Corner extension desk	EQ-D-CX-428429-C4	42	84	29	172	1621
------------------------------	--------------------------	----	----	----	-----	-------------

Full corner extension desk with column support.

Option	OPTION-GRC					48
---------------	-------------------	--	--	--	--	-----------

Add '-GRC' to the model number to order a worktop grommet in the corner of the top.

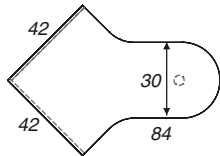

Corner Component

Corner Component

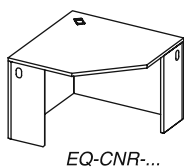

Corner Component	EQ-CNR-363629-24	36	36	29	126	1335
-------------------------	-------------------------	----	----	----	-----	-------------

Component	EQ-CNR-424229-24	42	42	29	126	1335
------------------	-------------------------	----	----	----	-----	-------------

Uses 24" deep return.

GRC grommet in corner of top is included.

Two 8" long angle brackets are included. These are used with the brackets included with the return and bridge components to attach returns or bridges to this corner component.

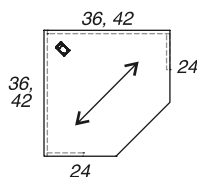

*Equations Standard qualifies for MAGNA NOW! 10 day shipping program, except for models with glass doors.

You must specify MAGNA NOW! on your purchase order. For large orders, please check with Customer Service for leadtime.

EQUATIONS - Component Pricing

Description	Model	Dimensions			Wgt	List Prices WoodPlus Edge
		Deep	Long	High		

Return

Returns with End Panel

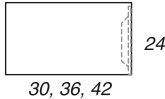
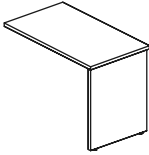

Return	EQ-R-TT-243029	24	30	29	50	456
	EQ-R-TT-243629	24	36	29	55	459
	EQ-R-TT-244229	24	42	29	59	475

Do not use this type of return to support hutch end.

Options	OPTION-MP-RETURN	168
	OPTION-GRC	48
	OPTION-GRE	48

Add '-MP' to order an optional Modesty Panel for the return.

Add '-GRC' to model number for grommet in center of top at back.

Add '-GRE' to model number for grommet at end of top, centered front to back.

Do NOT order both GRC and a GRE grommet for one top.

Returns include hardware to connect to desk, credenza or corner unit.

Return with Single Pedestal

Returns with Pedestal

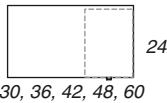
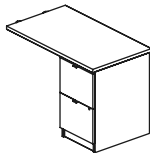
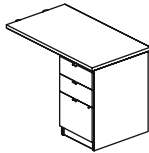

Box Box File pedestal	EQ-R-TT-243029-BBF	24	30	29	108	1064
	EQ-R-TT-243629-BBF	24	36	29	113	1067
	EQ-R-TT-244229-BBF	24	42	29	117	1083
	EQ-R-TT-244829-BBF	24	48	29	122	1094
	EQ-R-TT-245429-BBF	24	54	29	127	1156
	EQ-R-TT-246029-BBF	24	60	29	136	1206

Box Box File pedestal with lock. Specify pull.

File File pedestal	EQ-R-TT-243029-FF	24	30	29	108	1064
	EQ-R-TT-243629-FF	24	36	29	113	1067
	EQ-R-TT-244229-FF	24	42	29	117	1083
	EQ-R-TT-244829-FF	24	48	29	122	1094
	EQ-R-TT-245429-FF	24	54	29	127	1156
	EQ-R-TT-246029-FF	24	60	29	136	1206

File File pedestal with lock. Specify pull.

Options	OPTION-GRC	48
	OPTION-MP-RETURN	168

Add '-MP' to order an optional Modesty Panel for the return.

Add '-GRC' to model number to order grommet in center of top at back (available on sizes 36 long through 60 long).

Returns include hardware to connect to desk, credenza or corner unit.

Pedestal may be either to the left or right of the top.

***Equations Standard qualifies for MAGNA NOW! 10 day shipping program, except for models with glass doors.**

You must specify MAGNA NOW! on your purchase order. For large orders, please check with Customer Service for leadtime.

EQUATIONS - Component Pricing

Description	Model	Dimensions			Wgt	List Prices WoodPlus Edge
		Deep	Long	High		

Return with Single Lateral File 30 wide

Returns with Cabinets

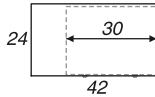
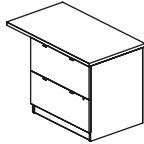

Lateral File	EQ-R-TT-244229-LF30	24	42	29	173	1451
---------------------	----------------------------	----	----	----	-----	-------------

30 wide two lateral file drawer cabinet with lock. Specify pull.

Options	OPTION-MP-RETURN					168
----------------	-------------------------	--	--	--	--	------------

Add '-MP' to order an optional Modesty Panel for the return.

Returns include hardware to connect to desk, credenza or corner unit.
Cabinet may be either to the left or right.

Return with Combo Cabinet or Lateral File

Returns with Cabinets

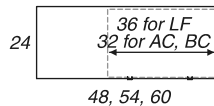
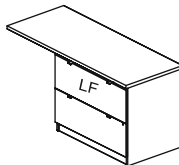
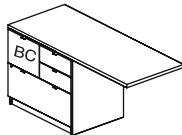
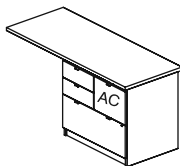

Combo A	EQ-R-TT-244829-AC	24	48	29	178	1462
	EQ-R-TT-245429-AC	24	54	29	183	1480
	EQ-R-TT-246029-AC	24	60	29	188	1500

32 wide Combo cabinet includes Lateral File drawer and File drawer locked.
Two Box drawers not locked. Specify pull.

Combo B	EQ-R-TT-244829-BC	24	48	29	178	1462
	EQ-R-TT-245429-BC	24	54	29	183	1480
	EQ-R-TT-246029-BC	24	60	29	188	1500

32 wide Combo cabinet includes Lateral File drawer and File drawer locked.
Two Box drawers not locked. Specify pull.

Lateral File	EQ-R-TT-244829-LF	24	48	29	178	1462
	EQ-R-TT-245429-LF	24	54	29	183	1480
	EQ-R-TT-246029-LF	24	60	29	188	1500

36 wide two drawer Lateral File cabinet with lock. Specify pull.

Options	OPTION-MP-RETURN					168
----------------	-------------------------	--	--	--	--	------------

Add '-MP' to order an optional Modesty Panel for the return.

Returns include hardware to connect to desk, credenza or corner unit.
Cabinet may be either to the left or right.

Radius End Desk Extension

Radius End Returns
attach to Credenza
or Desk unit

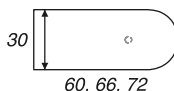
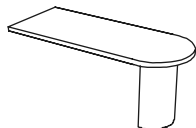
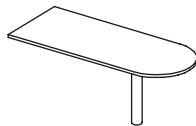

Column support	EQ-DE-RE-306029-C4	30	60	29	67	806
	EQ-DE-RE-306629-C4	30	66	29	73	841
	EQ-DE-RE-307229-C4	30	72	29	79	865
	OPTION-TAPERED-LEG				8	78

Add '-TL' to model number to order a Tapered Leg in place of the 4 column

Half Cylinder	EQ-DE-RE-306029-HC	30	60	29	67	1325
	EQ-DE-RE-306629-HC	30	66	29	73	1361
	EQ-DE-RE-307229-HC	30	72	29	79	1384

Returns include hardware to connect to desk, credenza or corner unit.

*Equations Standard qualifies for MAGNA NOW! 10 day shipping program, except for models with glass doors.

You must specify MAGNA NOW! on your purchase order. For large orders, please check with Customer Service for leadtime.

EQUATIONS - Component Pricing

Description	Model	Dimensions			Wgt	List Prices <small>WoodPlus Edge</small>
		Deep	Long	High		

Keyhole top Desk Extension

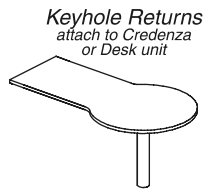

Column	EQ-DE-KH-366029-C4	36	60	29	61	984
Support	EQ-DE-KH-366629-C4	36	66	29	67	1018
	EQ-DE-KH-367229-C4	36	72	29	73	1042
	OPTION-TAPERED-LEG					78

Returns include hardware to connect to desk, credenza or corner unit.

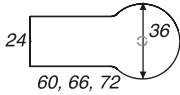

P top Desk Extension

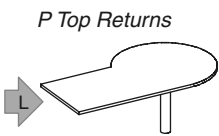

Column	EQ-DE-P-426029-C4-R	42	60	29	89	984
support,	EQ-DE-P-426629-C4-R	42	66	29	97	1018
Desk or	EQ-DE-P-427229-C4-R	42	72	29	105	1042
Pedestal Left	OPTION-TAPERED-LEG					78

To order the Tapered Leg in place of the 4 inch column add '-TL' to the model number.

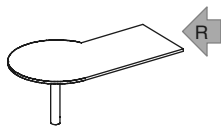

Column	EQ-DE-P-426029-C4-L	42	60	29	89	984
support,	EQ-DE-P-426629-C4-L	42	66	29	97	1018
Desk or	EQ-DE-P-427229-C4-L	42	72	29	105	1042
Pedestal Right	OPTION-TAPERED-LEG					78

To order the Tapered Leg in place of the 4 inch column add '-TL' to the model number.

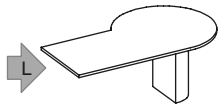

Modesty panel,	EQ-DE-P-426029-HC-R	42	60	29	108	1505
Desk or	EQ-DE-P-426629-HC-R	42	66	29	116	1541
	EQ-DE-P-427229-HC-R	42	72	29	124	1564

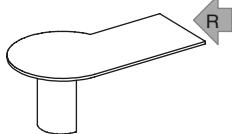

Pedestal Left						
Modesty panel,	EQ-DE-P-426029-HC-L	42	60	29	108	1505
Desk or	EQ-DE-P-426629-HC-L	42	66	29	116	1541
	EQ-DE-P-427229-HC-L	42	72	29	124	1564

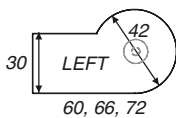

Pedestal Right
Returns include hardware to connect to desk, credenza or corner unit.

Bridge

Bridge Tops

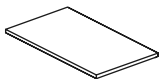

Bridge	EQ-B-TT-243029	24	30	29	28	267
	EQ-B-TT-243629	24	36	29	33	270
	EQ-B-TT-244229	24	42	29	37	286
	EQ-B-TT-244829	24	48	29	45	368
	EQ-B-TT-245429	24	54	29	51	389

Options	OPTION-MP-BRIDGE					168
	OPTION-GRC					48

48" and 54" bridge include an EQ-TOPRAIL-48 or 54 as needed.

Add '-MP' to order an optional Modesty Panel for the bridge.

Add '-GRC' to order an optional Grommet at the center back of the worktop.

Bridge Includes hardware to connect to desk, corner or credenza components (both ends).

with optional Modesty Panel

***Equations Standard qualifies for MAGNA NOW! 10 day shipping program, except for models with glass doors.**

You must specify MAGNA NOW! on your purchase order. For large orders, please check with Customer Service for leadtime.

EQUATIONS - Component Pricing

Description	Model	Dimensions			Wgt	List Prices WoodPlus Edge
		Deep	Long	High		

Credenzas, U configuration, with pedestals, lateral files, combo cabinets

24" Deep Credenzas

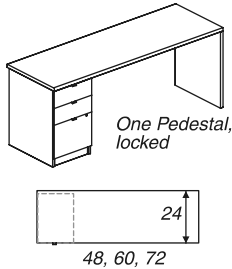

Box Box File	EQ-CR-TT-244829-BBF	24	48	29	144	1283
	EQ-CR-TT-246029-BBF	24	60	29	158	1395
	EQ-CR-TT-247229-BBF	24	72	29	168	1432

Box Box File pedestal with lock. Specify pull.

Two File Drawers	EQ-CR-TT-244829-FF	24	48	29	144	1283
	EQ-CR-TT-246029-FF	24	60	29	158	1395
	EQ-CR-TT-247229-FF	24	72	29	168	1432

Two File drawer pedestal with lock. Specify pull.

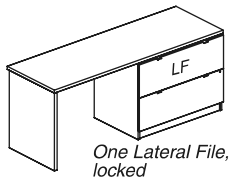

Lateral File	EQ-CR-TT-246029-LF	24	60	29	210	1689
	EQ-CR-TT-247229-LF	24	72	29	219	1717

One each 36 wide two drawer lateral file cabinet with lock. Specify pull.

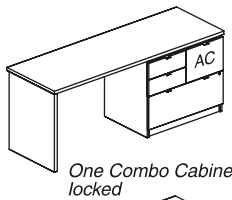

Combo-A	EQ-CR-TT-246029-AC	24	60	29	210	1689
	EQ-CR-TT-247229-AC	24	72	29	219	1717

One each Combo-A cabinet with one LF drawer and one File drawer, both are locked. Two Box drawers are not locked. Specify pull.

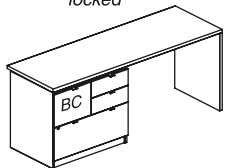

Combo-B	EQ-CR-TT-246029-BC	24	60	29	210	1689
	EQ-CR-TT-247229-BC	24	72	29	219	1717

One each Combo-B cabinet with one LF drawer and one File drawer, both are locked. Two Box drawers are not locked. Specify pull.

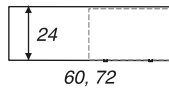

Options	OPTION-MP-CREDEENZA					168
	OPTION-GRE					48

Add '-MP' to order an optional Modesty Panel for the credenza.

Add '-GRE' to order an optional Grommet at one end of the worktop, centered front to back.

*Equations Standard qualifies for MAGNA NOW! 10 day shipping program, except for models with glass doors.

You must specify MAGNA NOW! on your purchase order. For large orders, please check with Customer Service for leadtime.

EQUATIONS - Component Pricing

Description	Model	Dimensions			Wgt	List Prices <small>WoodPlus Edge</small>
		Deep	Long	High		

Credenzas, stand alone, with double pedestals

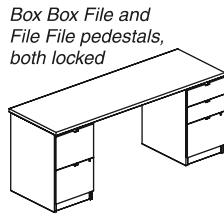

BBF and FF	EQ-CR-TT-246029-FF-BBF	24	60	29	212	1929
	EQ-CR-TT-247229-FF-BBF	24	72	29	221	1957

Box Box File pedestal with lock. File File pedestal with lock. Specify pull.

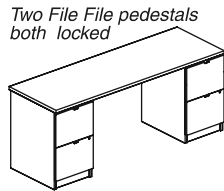

Two each FF	EQ-CR-TT-246029-FF-FF	24	60	29	212	1929
	EQ-CR-TT-247229-FF-FF	24	72	29	221	1957

Two each File File pedestal with lock. Specify pull.

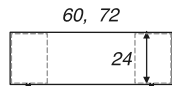

Options	OPTION-MP-CREDENZA					168
	OPTION-GRC					48

Add '-MP' to order an optional Modesty Panel for the credenza.

Add '-GRC' to order an optional grommet at the center back of worktop.

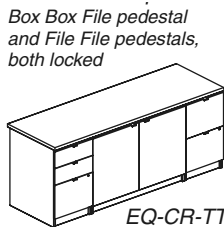

Credenzas, stand alone, filled with pedestals and door storage

BBF and FF,	EQ-CR-TT-246029-BBF-DS-FF	24	60	29	337	2755
Door storage	EQ-CR-TT-247229-BBF-DS-FF	24	72	29	369	2866

Box Box File pedestal with lock. File File pedestal with lock. Door storage between pedestals. Specify pull.

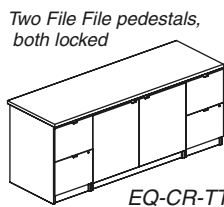

2 File File	EQ-CR-TT-246029-FF-DS-FF	24	60	29	337	2755
Door storage	EQ-CR-TT-247229-FF-DS-FF	24	72	29	369	2866

Two each File File pedestals with lock. Door storage between pedestals. Specify pull.

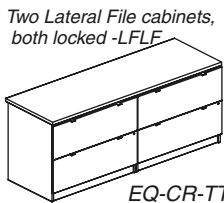
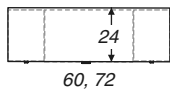

Two Lateral Files	EQ-CR-TT-246029-LF-LF	24	60	29	324	2665
	EQ-CR-TT-247229-LF-LF	24	72	29	333	2693

Two each two drawer lateral file cabinets with locks. Specify pull..

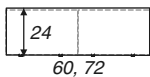

Options	OPTION-MP-CREDENZA					168
	OPTION-DS-LOCK					87

Add '-MP' to order an optional Modesty Panel for the credenza.

To add a lock to a DS Door Storage unit, change the DS to DSLOCK

***Equations Standard qualifies for MAGNA NOW! 10 day shipping program, except for models with glass doors.**

You must specify MAGNA NOW! on your purchase order. For large orders, please check with Customer Service for leadtime.

EQUATIONS - Component Pricing

Description	Model	Dimensions			Wgt	List Prices WoodPlus Edge
		Deep	Long	High		

Credenzas, stand alone, filled with door or open storage

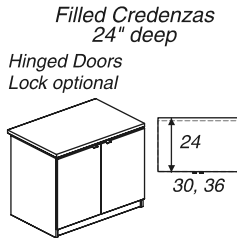

Door Storage	EQ-CR-TT-243029-DS	24	30	29	149	1040
24 deep	EQ-CR-TT-243629-DS	24	36	29	167	1043
LOCK-ONE-PR-HINGED-DOORS						87

One door storage cabinet with one pair of hinged doors. Specify pull.

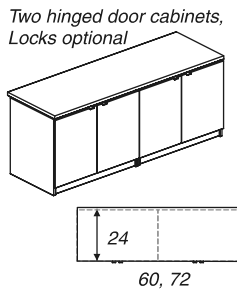

	EQ-CR-TT-246029-DS-DS	24	60	29	298	1913
	EQ-CR-TT-247229-DS-DS	24	72	29	333	1941
LOCK-TWO-PR-HINGED-DOORS						174

Two door storage cabinets, each with one pair of hinged doors. Specify pull.

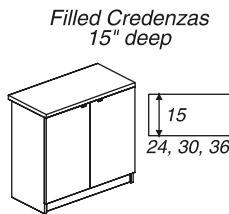

Door Storage	EQ-CR-TT-152429-DS	15	24	29	81	932
15 deep	EQ-CR-TT-153029-DS	15	30	29	95	1025
	EQ-CR-TT-153629-DS	15	36	29	111	1043
LOCK-ONE-PR-HINGED-DOORS						87

One door storage cabinet with one pair of hinged doors. Specify pull.

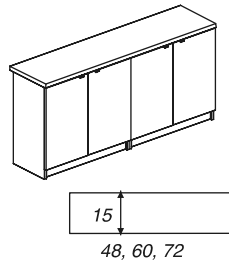

	EQ-CR-TT-154829-DS-DS	15	48	29	162	1757
	EQ-CR-TT-156029-DS-DS	15	60	29	190	1913
	EQ-CR-TT-157229-DS-DS	15	72	29	222	1941
LOCK-TWO-PR-HINGED-DOORS						174

Two each door storage cabinets with one pair of doors per cabinet. Specify pull.

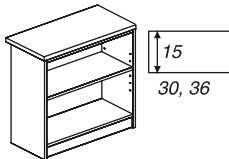

Open Storage	EQ-CR-TT-153029-OS	15	30	29	72	728
15 deep	EQ-CR-TT-153629-OS	15	36	29	84	746

One open storage cabinet.

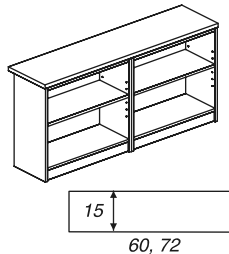

	EQ-CR-TT-156029-OS-OS	15	60	29	144	1319
	EQ-CR-TT-157229-OS-OS	15	72	29	168	1347

Two each open storage cabinets.

Options	OPTION-MP-CREDENZA				42	168
----------------	---------------------------	--	--	--	----	------------

Add ' -MP' to order an optional Modesty Panel for the credenza.

*Equations Standard qualifies for MAGNA NOW! 10 day shipping program, except for models with glass doors.

You must specify MAGNA NOW! on your purchase order. For large orders, please check with Customer Service for leadtime.

EQUATIONS - Component Pricing

<i>Description</i>	<i>Model</i>	<i>Dimensions</i>			<i>Wgt</i>	<i>List Prices</i>
		<i>Deep</i>	<i>Long</i>	<i>High</i>		<i>WoodPlus Edge</i>

Hutches at Standard Height -35 - matches towers at 65 high

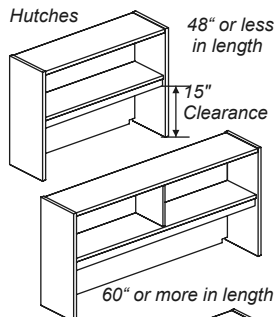

Open Hutch	EQ-H-TI-153035	15	30	35	86	679
	EQ-H-TI-153635	15	36	35	93	679
	EQ-H-TI-154235	15	42	35	101	750
	EQ-H-TI-154835	15	48	35	108	750
	EQ-H-TI-156035	15	60	35	129	776
	EQ-H-TI-156635	15	66	35	144	809
	EQ-H-TI-157235	15	72	35	159	809
	EQ-H-TI-157835	15	78	35	173	890
	EQ-H-TI-158435	15	84	35	182	890
	EQ-H-TI-159035	15	90	35	192	1176
	EQ-H-TI-159635	15	96	35	202	1176

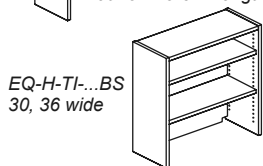

Bookshelf hutch	EQ-H-TI-153035-BS	15	30	35	86	719
	EQ-H-TI-153635-BS	15	36	35	93	719

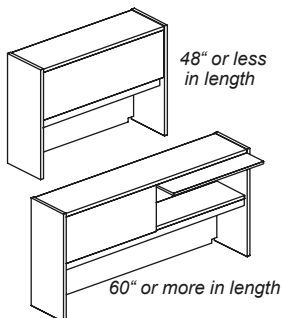

Flipper Door	EQ-H-TI-153035-FD	15	30	35	86	998
	EQ-H-TI-153635-FD	15	36	35	93	998
	EQ-H-TI-154235-FD	15	42	35	101	1075
	EQ-H-TI-154835-FD	15	48	35	112	1075
2 flipper doors	EQ-H-TI-156035-FD	15	60	35	147	1362
	EQ-H-TI-156635-FD	15	66	35	164	1399
	EQ-H-TI-157235-FD	15	72	35	181	1399
	EQ-H-TI-157835-FD	15	78	35	173	1484
	EQ-H-TI-158435-FD	15	84	35	182	1484
	EQ-H-TI-159035-FD	15	90	35	192	1869
	EQ-H-TI-159635-FD	15	96	35	202	1869

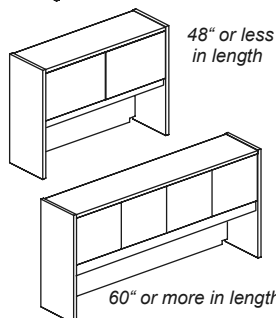

Hinged Doors	EQ-H-TI-153035-HD	15	30	35	86	998
	EQ-H-TI-153635-HD	15	36	35	93	998
	EQ-H-TI-154235-HD	15	42	35	101	1075
	EQ-H-TI-154835-HD	15	48	35	112	1075
2 pair of doors	EQ-H-TI-156035-HD	15	60	35	147	1362
	EQ-H-TI-156635-HD	15	66	35	164	1399
	EQ-H-TI-157235-HD	15	72	35	181	1399
	EQ-H-TI-157835-HD	15	78	35	173	1484
	EQ-H-TI-158435-HD	15	84	35	182	1484
	EQ-H-TI-159035-HD	15	90	35	192	1941
	EQ-H-TI-159635-HD	15	96	35	202	1941

Use -GA for glass doors with Aluminum frames or change to -GW for WoodPlus2 frames

GA
Hinged Glass
Doors Aluminum
Frames on all
four edges

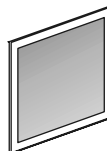

Glass Doors, aluminum or WoodPlus2 frames	EQ-H-TI-153035-GA or GW	15	30	35	131	1407
	EQ-H-TI-153635-GA or GW	15	36	35	93	1436
	EQ-H-TI-154235-GA or GW	15	42	35	103	1573
	EQ-H-TI-154835-GA or GW	15	48	35	118	1708
2 pair of doors	EQ-H-TI-156035-GA or GW	15	60	35	147	2165
	EQ-H-TI-156635-GA or GW	15	66	35	164	2262
	EQ-H-TI-157235-GA or GW	15	72	35	181	2320
	EQ-H-TI-157835-GA or GW	15	78	35	173	2464
	EQ-H-TI-158435-GA or GW	15	84	35	182	2523
	EQ-H-TI-159035-GA or GW	15	90	35	192	3152
	EQ-H-TI-159635-GA or GW	15	96	35	202	3291

GW
Hinged Glass
Doors WoodPlus2
Frames on all
four edges

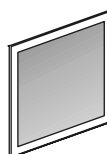

For locks on FD add \$87 per door. For locks no HD add \$87 per pair of doors.

GA = glass doors - aluminum frames; GW = glass doors - WoodPlus2 frame.
GA or GW doors use frosted glass.
For clear glass, please add List \$210 per unit and '-CLEAR' to model name.

EQUATIONS - Component Pricing

Description	Model	Dimensions			Wgt	List Prices WoodPlus Edge		
		Deep	Long	High				
Hutches at Extended Height -42 - matches towers at 72 high								
Hutches - Extended Height 	Open Hutch	EQ-H-TI-153042	15	30	42	86	718	
		EQ-H-TI-153642	15	36	42	93	718	
		EQ-H-TI-154242	15	42	42	101	790	
		EQ-H-TI-154842	15	48	42	123	790	
		EQ-H-TI-156042	15	60	42	138	817	
		EQ-H-TI-156642	15	66	42	153	849	
		EQ-H-TI-157242	15	72	42	168	849	
		EQ-H-TI-157842	15	78	42	195	968	
		EQ-H-TI-158442	15	84	42	205	968	
		EQ-H-TI-159042	15	90	42	216	1253	
		EQ-H-TI-159642	15	96	42	228	1253	
Bookshelf hutch 		EQ-H-TI-153042-BS	15	30	42	86	761	
		EQ-H-TI-153642-BS	15	36	42	93	761	
Flipper Door 		EQ-H-TI-153042-FD	15	30	42	86	1041	
		EQ-H-TI-153642-FD	15	36	42	93	1041	
		EQ-H-TI-154242-FD	15	42	42	102	1120	
		EQ-H-TI-154842-FD	15	48	42	127	1120	
2 flipper doors 		EQ-H-TI-156042-FD	15	60	42	142	1406	
		EQ-H-TI-156642-FD	15	66	42	157	1442	
		EQ-H-TI-157242-FD	15	72	42	172	1442	
		EQ-H-TI-157842-FD	15	78	42	195	1563	
		EQ-H-TI-158442-FD	15	84	42	205	1563	
		EQ-H-TI-159042-FD	15	90	42	216	1949	
		EQ-H-TI-159642-FD	15	96	42	228	1949	
Hinged Doors 		EQ-H-TI-153042-HD	15	30	42	86	1041	
		EQ-H-TI-153642-HD	15	36	42	93	1041	
		EQ-H-TI-154242-HD	15	42	42	102	1120	
		EQ-H-TI-154842-HD	15	48	42	127	1120	
2 pair of doors 		EQ-H-TI-156042-HD	15	60	42	142	1406	
		EQ-H-TI-156642-HD	15	66	42	157	1442	
		EQ-H-TI-157242-HD	15	72	42	172	1442	
		EQ-H-TI-157842-HD	15	78	42	195	1563	
		EQ-H-TI-158442-HD	15	84	42	205	1563	
		EQ-H-TI-159042-HD	15	90	42	216	2021	
		EQ-H-TI-159642-HD	15	96	42	228	2021	
Use -GA for glass doors with Aluminum frames or change to -GW for WoodPlus2 frames								
Glass Doors, 	aluminum or	EQ-H-TI-153042-GA or GW	15	30	42	86	1450	
	WoodPlus2	EQ-H-TI-153642-GA or GW	15	36	42	93	1477	
	frames	EQ-H-TI-154242-GA or GW	15	42	42	103	1616	
		EQ-H-TI-154842-GA or GW	15	48	42	118	1752	
	2 pair of doors 		EQ-H-TI-156042-GA or GW	15	60	42	142	2205
			EQ-H-TI-156642-GA or GW	15	66	42	157	2299
			EQ-H-TI-157242-GA or GW	15	72	42	172	2360
			EQ-H-TI-157842-GA or GW	15	78	42	195	2540
			EQ-H-TI-158442-GA or GW	15	84	42	205	2600
			EQ-H-TI-159042-GA or GW	42	90	42	216	3228
	EQ-H-TI-159642-GA or GW	15	96	42	228	3368		

For locks on FD add \$87 per door. For locks no HD add \$87 per pair of doors.

GA = glass doors - aluminum frames; GW = glass doors - WoodPlus2 frame.
 GA or GW doors use frosted glass.
 For clear glass, please add List \$210 per unit and '-CLEAR' to model name.

EQUATIONS - Component Pricing

Description	Model	Dimensions			Wgt	List Prices WoodPlus Edge
		Deep	Long	High		

Hutches with Shaped Doors

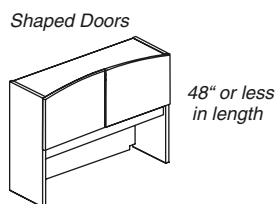

Shaped Doors-35 high	EQ-H-TI-153035-SD	15	30	35	86	1069
	EQ-H-TI-153635-SD	15	36	35	93	1069
	EQ-H-TI-154235-SD	15	42	35	101	1146
	EQ-H-TI-154835-SD	15	48	35	112	1146

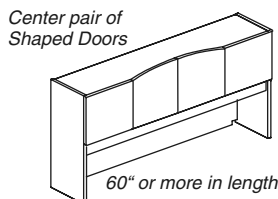

Center Shaped Doors	EQ-H-TI-156035-SD	15	60	35	142	1433
	EQ-H-TI-156635-SD	15	66	35	157	1470
	EQ-H-TI-157235-SD	15	72	35	172	1470
	EQ-H-TI-157835-SD	15	78	35	173	1555
	EQ-H-TI-158435-SD	15	84	35	182	1555
	EQ-H-TI-159035-SD	15	90	35	192	2012
	EQ-H-TI-159635-SD	15	96	35	202	2012

No applied Pull available for hutches with shaped doors.
Locks are not available on glass or shaped doors.

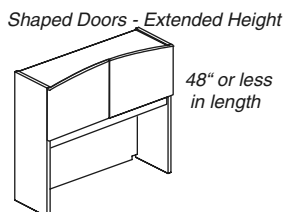

Shaped Doors 42" high	EQ-H-TI-153042-SD	15	30	42	86	1113
	EQ-H-TI-153642-SD	15	36	42	93	1113
	EQ-H-TI-154242-SD	15	42	42	102	1191
	EQ-H-TI-154842-SD	15	48	42	127	1191

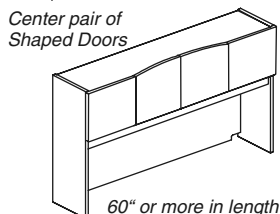

Center Shaped Doors	EQ-H-TI-156042-SD	15	60	42	147	1477
	EQ-H-TI-156642-SD	15	66	42	164	1513
	EQ-H-TI-157242-SD	15	72	42	181	1513
	EQ-H-TI-157842-SD	15	78	42	195	1634
	EQ-H-TI-158442-SD	15	84	42	205	1634
	EQ-H-TI-159042-SD	15	90	42	216	2092
	EQ-H-TI-159642-SD	15	96	42	228	2092

No applied Pull available for hutches with shaped doors.
Locks are not available on glass or shaped doors.

Hutches at 35" high have 15.75" clear below valance and above worksurface.
Hutches at 42" high have 22.25" clear below valance and above worksurface.

Locks for hutch hinged doors HD or flipper doors FD only

LOCK FOR ONE PAIR OF HINGED DOORS (48" OR LESS IN LENGTH)	87
LOCK FOR TWO PAIRS OF HINGED DOORS (OVER 48" LONG)	174
LOCK FOR ONE FLIPPER DOOR (48" OR LESS IN LENGTH)	87
LOCK FOR TWO FLIPPER DOORS (OVER 48" LONG)	174

RTA Option

Ship any Hutch RTA (ready to assemble) at no charge. All hardware is included; all holes are pre-bored. Add RTA to the beginning of model number. Order FPI to cover exposed fasteners.

EQUATIONS - Component Pricing

Description	Model	Dimensions			Wgt	List Prices WoodPlus Edge
		Deep	Long	High		

Desk Top Organizers

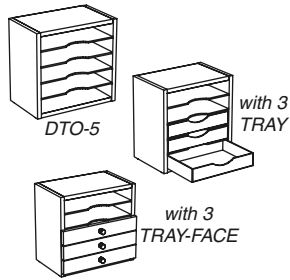

Desk Top Organizer	DTO-5	9.60	15.00	15.68	18	274
	DTO-6	9.60	15.00	18.53	19	274
	DTO-TRAY-ABS	8.63	13.25	2.5	1	46
	DTO-TRAY-FACE	9.38	13.25	2.6	1	67

DTO-5 fits below the valance of a 35" high hutch
 DTO-5 fits below the valance of a 42" high hutch with PSS
 DTO-6 fits below the valance of a 42" high hutch

Please specify a finish for the Knob pull if you are ordering a tray with a face.
 Pull 9 is matte Black and matches #12, 14 or 18.
 Pull 10 is Black Chrome and matches #10.
 Pull 11 is Satin Chrome and matches #13, 15 or 19.

Hutch fabric panels FPI

Note: Our fabric usage is updated. All fabrics are now installed on tackboards with the 'direction' (the length of the fabric as it is pulled off the roll) vertical.

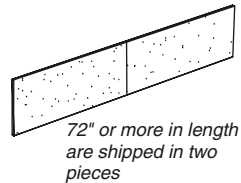
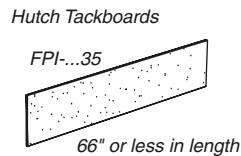

Tackboards for hutch at 35" high	FPI-30L-35H	0.5	27	17.5	3	222
	FPI-36L-35H	0.5	33	17.5	5	222
	FPI-42L-35H	0.5	39	17.5	6	222
	FPI-48L-35H	0.5	45	17.5	7	222
	FPI-60L-35H	0.5	57	17.5	9	222
	FPI-66L-35H	0.5	63	17.5	10	254
FPI fabric panels that are 72" or longer are made in two pieces.						
	FPI-72L-35H	0.5	69	17.5	11	254
	FPI-78L-35H	0.5	75	17.5	12	286
	FPI-84L-35H	0.5	81	17.5	13	286
	FPI-90L-35H	0.5	87	17.5	14	286
	FPI-96L-35H	0.5	93	17.5	15	286

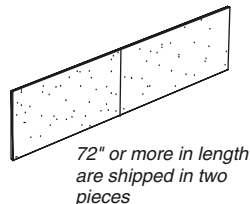
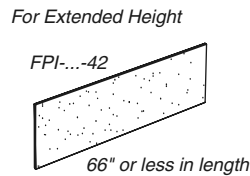

Tackboards for hutch at 42" high	FPI-30L-42H	0.5	27	24.5	4	222
	FPI-36L-42H	0.5	33	24.5	6	222
	FPI-42L-42H	0.5	39	24.5	8	222
	FPI-48L-42H	0.5	45	24.5	9	222
	FPI-60L-42H	0.5	57	24.5	10	222
	FPI-66L-42H	0.5	63	24.5	11	254
FPI fabric panels that are 72" or longer are made in two pieces.						
	FPI-72L-42H	0.5	69	24.5	12	254
	FPI-78L-42H	0.5	75	24.5	12	286
	FPI-84L-42H	0.5	81	24.5	13	286
	FPI-90L-42H	0.5	87	24.5	14	286
	FPI-96L-42H	0.5	93	24.5	15	286

For MagnaNOW! Fabrics, please see the FPW section (next page)
 Most standard Guilford Panel Fabrics are available on MagnaFLEX lead time.
 If the fabric is not listed in our specifications,
 please contact factory for Fabric Grade, availability, lead time and pricing.
 Pricing shown is for Magna designated Fabric Grades A, B, C.

Hutch fabric panels "FPI" are shipped as two piece units when 72" or longer in length.

For COM fabric, please use the pricing shown above. A sample of the COM fabric plus the fabric specifications such as width of roll, directional or non-directional is required.

EQUATIONS - Component Pricing

<i>Description</i>	<i>Model</i>	<i>Dimensions</i>			<i>Wgt</i>	<i>List Prices</i> <i>WoodPlus Edge</i>
		<i>Deep</i>	<i>Long</i>	<i>High</i>		

Overhead Tech Cabinets, Wall Mounted

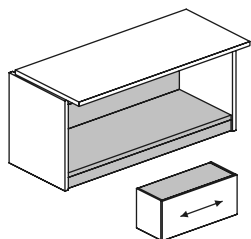

Flipper Door Wall Mount,
30" to 60" wide

Flipper door	EQ-OW-153016-FDT	14.75	30	16	46	685
	EQ-OW-153616-FDT	14.75	36	16	53	740
	EQ-OW-154216-FDT	14.75	42	16	60	790
	EQ-OW-154816-FDT	14.75	48	16	67	822
	OPTION-LOCK-FLIPPER-DOOR					87

Two flipper doors	EQ-OW-155416-FDT	14.75	54	16	74	1011
	EQ-OW-156016-FDT	14.75	60	16	81	1049
	OPTION-LOCK-FLIPPER-DOORS					174

Add '-LOCK' to model number to lock doors

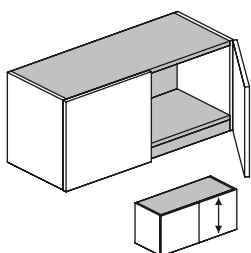

Hinged Door Wall Mount,
30" to 60" wide

Hinged doors	EQ-OW-153016-HDT	14.75	30	16	46	685
	EQ-OW-153616-HDT	14.75	36	16	53	740
	EQ-OW-154216-HDT	14.75	42	16	60	790
	EQ-OW-154816-HDT	14.75	48	16	67	822
	LOCK-ONE-PAIR-DOORS					87

Two pair hinged doors	EQ-OW-155416-HDT	14.75	54	16	74	1011
	EQ-OW-156016-HDT	14.75	60	16	81	1049
	LOCK-TWO-PAIR-DOORS					174

Add '-LOCK' to model number to lock doors. Specify Pull.

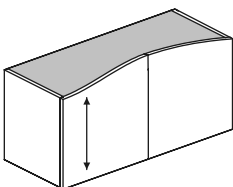

Hinged Door Wall Mount,
30" to 60" wide

Shaped hinged doors	EQ-OW-153016-SDT	14.75	30	16	46	757
	EQ-OW-153616-SDT	14.75	36	16	53	812
	EQ-OW-154216-SDT	14.75	42	16	60	862
	EQ-OW-154816-SDT	14.75	48	16	67	894

Two pairs center doors are shaped	EQ-OW-155416-SDT	14.75	54	16	74	1082
	EQ-OW-156016-SDT	14.75	60	16	81	1120

Pulls and Locks are not available on shaped doors

Glass doors aluminum frame	EQ-OW-153016-HGAT	14.75	30	16	46	1094
	EQ-OW-153616-HGAT	14.75	36	16	53	1178
	EQ-OW-154216-HGAT	14.75	42	16	60	1288
	EQ-OW-154816-HGAT	14.75	48	16	67	1455

Two pair of doors	EQ-OW-155416-HGAT	14.75	54	16	74	1814
	EQ-OW-156016-HGAT	14.75	60	16	81	1852

Pulls and Locks are not available on glass doors

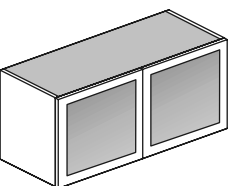

Glass Door with Aluminum or WoodPlus2 frame,
Wall Mount, 30" to 60" wide

Glass doors WoodPlus2 frame	EQ-OW-153016-HGWT	14.75	30	16	46	1094
	EQ-OW-153616-HGWT	14.75	36	16	53	1178
	EQ-OW-154216-HGWT	14.75	42	16	60	1288
	EQ-OW-154816-HGWT	14.75	48	16	67	1455

Two pair of doors	EQ-OW-155416-HGWT	14.75	54	16	74	1814
	EQ-OW-156016-HGWT	14.75	60	16	81	1852

Pulls and Locks are not available on glass doors.

GA = glass doors - aluminum frames; GW = glass doors - WoodPlus2 frame.

GA or GW doors use frosted glass.

For clear glass, please add List \$210 per unit and '-CLEAR' to model name.

WoodPlus2 glass door frames are detailed to match Equations Standard details.

Specify WP2 or XTRA WP2 finish for the door frames.

Note that the XTRA WP2 upcharge applies when choosing an XTRA WP2 finish.

EQUATIONS - Component Pricing

Description	Model	Dimensions			Wgt	List Prices <small>WoodPlus Edge</small>
		Deep	Long	High		



Tackboards, wall mounted

Note: All fabrics are now installed on tackboards with the 'direction' (the length of the fabric as it is pulled off the roll) vertical.

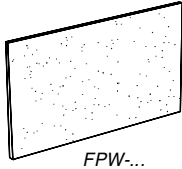

Tackboards 18 high	FPW-30L-18H	0.5	30	18	5	222	
	FPW-36L-18H	0.5	36	18	5	222	
	FPW-42L-18H	0.5	42	18	5	222	
	FPW-48L-18H	0.5	48	18	5	222	
	FPW-54L-18H	0.5	54	18	10	222	
	FPW-60L-18H	0.5	60	18	10	222	
	FPW fabric panels that are 66" or longer are made in two pieces.						
	FPW-66L-18H	0.5	66	18	10	254	
	FPW-72L-18H	0.5	72	18	10	254	
	FPW-78L-18H	0.5	78	18	10	286	
FPW-84L-18H	0.5	84	18	10	286		
FPW-90L-18H31	0.5	90	18	10	286		
FPW-96L-18H	0.5	96	18	10	286		

18" high panels fit between worktop and wall mounted overhead when overhead aligns with standard height hutch or 65 high tower.

Tackboards "FPW" are shipped in two pieces when 66" or longer.

Tackboards 25 high	FPW-30L-25H	0.5	30	25	7	222	
	FPW-36L-25H	0.5	36	25	7	222	
	FPW-42L-25H	0.5	42	25	7	222	
	FPW-48L-25H	0.5	48	25	7	222	
	FPW-54L-25H	0.5	54	25	12	222	
	FPW-60L-25H	0.5	60	25	12	222	
	FPW fabric panels that are 66" or longer are made in two pieces.						
	FPW-66L-25H	0.5	66	25	12	254	
	FPW-72L-25H	0.5	72	25	12	254	
	FPW-78L-25H	0.5	78	25	12	286	
FPW-84L-25H	0.5	84	25	12	286		
FPW-90L-25H	0.5	90	25	12	286		
FPW-96L-25H	0.5	96	25	12	286		

25" high panels fit between worktop and wall mounted overhead when overhead aligns with extended height hutch or 72 high tower.

Tackboards "FPW" are shipped in two pieces when 66" or longer.

FPW- to 60" long - 18" or less in height	222
FPW- to 60" long - 25" or less in height	222
FPW- to 60" long - over 25" in height	254

The following Guilford fabrics are available for MagnaNOW!.

- 101) 2823-014 Hopstotch, Tictactoe (Gray)
- 102) 3548-040 Raku, Prism (Tan/taupe)
- 103) 3548-020 Raku, Porcelain (Tan/taupe & Gray)
- 104) 2100-380 FR701, Quartz (Tan/taupe)
- 105) 2818-010 Orissa, Kashmir (Tan/wheat)
- 106) 3548-060 Raku, Bottle (Green)
- 107) 2100-380 FR701 Rose Quartz (Rose)
- 108) 4052-053 Belgrade, Bluehill (Blue)

Most standard Guilford Panel Fabrics are available on MagnaFLEX lead time.*

If the fabric is not shown in our current specifications, see www.magnadesign.com, please contact factory for Fabric Grade, availability, lead time and pricing.

Pricing shown is for Magna designated Fabric Grades A, B, C.

For COM fabric, please use the pricing shown above. A sample of the COM fabric plus the fabric specifications such as width of roll, directional or non-directional is required.

Tasklights are available in Accessories at back of pricelist.

EQUATIONS - Component Pricing

Description	Model	Dimensions			Wgt	List Prices WoodPlus Edge
		Deep	Long	High		



Tables and Mobile pedestals

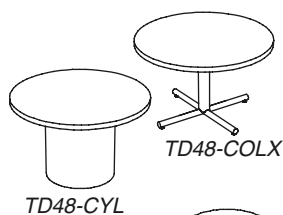

Column base	EQ-TD-4229-COLX	42	42	29	75	1176
	EQ-TD-4829-COLX	48	48	29	93	1245

Base finish is P1 Black or P8 Silver

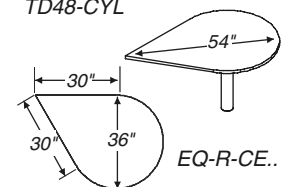

Cylinder base	EQ-TD-4229-CYL	42	42	29	140	1488
	EQ-TD-4829-CYL	48	48	29	155	1535
	OPTION-GRC	1.75	3.5			48

Add ' -GRC' to model number to order center grommet on top

Extension top	EQ-R-CE-365429-C4	36	54	29	67	876
---------------	-------------------	----	----	----	----	------------

Base finish is P1 Black or P8 Silver



Kidney tables	EQ-TK-243629-TLEG-CA	24	36	29	53	855
	EQ-TK-304229-C2-CA	30	42	29	66	916

Base finish is P1 Black or P8 Silver

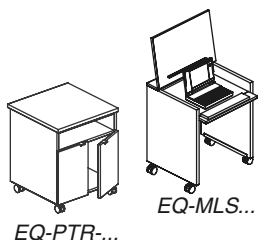

Mobile Laptop Storage	EQ-MLS-212429-CA	21	24	29	68	1228
-----------------------	------------------	----	----	----	----	-------------

Printer cabinet	EQ-PTR-TT-242429-CA	24	24	29	102	1456
-----------------	---------------------	----	----	----	-----	-------------

Specify Pull.

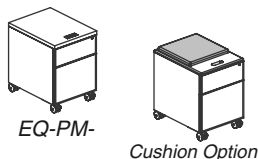

Mobile 3/4 pedestal	EQ-PM-211622-BF-CA	21	16	22	75	1127
	OPTION-EQ-PM-CUSHION	16	20	1	5	101

EQ-PM Box File pedestal on casters with lock may be stored underneath a worktop.

Specify Pull.

Optional black cushion may be ordered for the top of the EQ-PM case.

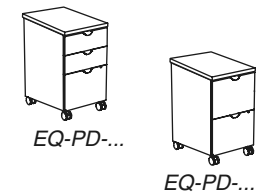

Mobile pedestal with top	EQ-PD-TT-241629-BBF-CA	24	16	29	82	1254
	EQ-PD-TT-241629-FF-CA	24	16	29	82	1254

EQ-PD mobile pedestals include a worktop 24 deep and 16 wide.

EQ-PD pedestal can be 'docked' next to a worktop to extend the worktop surface.

Specify Pull.

EQUATIONS - Component Pricing

Description	Model	Dimensions			Wgt	List Prices WoodPlus Edge
		Deep	Long	High		



Pedestals, Lateral File and Combo Components with worktop

EQ-CR-TT-241629-BBF

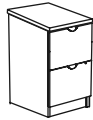

EQ-CR-TT-241629-FF

Pedestal	EQ-CR-TT-241629-BBF	24	16	29	82	1009
Top over	EQ-CR-TT-241629-FF	24	16	29	82	1009

A worktop at 24 deep and 16 long is included.
This pedestal can be 'docked' next to a worktop to extend the worktop surface.
Specify Pull.

Combo Cabinets and
Lateral Files

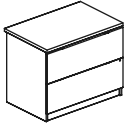
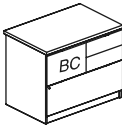
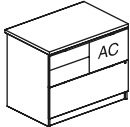

Combo A	EQ-CR-TT-243229-AC	24	32	29	165	1419
Top over						

Combo-A lateral file and file drawers are locked. Two box drawers are not locking. Specify Pull.
Drawer faces fully overlay ends of case
A worktop at 24 deep and 32 long is included

Combo B	EQ-CR-TT-243229-BC	24	32	29	165	1419
Top over						

Combo-B lateral file and file drawers are locked. Two box drawers are not locking. Specify Pull.
Drawer faces fully overlay ends of case
A worktop at 24 deep and 32 long is included

Two LF,	EQ-CR-TT-243029-LF	24	30	29	162	1416
Top over	EQ-CR-TT-243629-LF	24	36	29	167	1419

Two lateral file drawers are locked and fully overlay ends of case. Specify Pull.
Worktop at 24 deep and 30 or 36 long is included

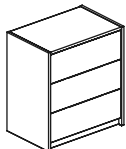

EQ-ST-TI-...-3LF

Three LF,	EQ-ST-TI-243041-3LF	24	30	41	284	1992
top inset	EQ-ST-TI-243641-3LF	24	36	41	292	1992

Three lateral file drawers are locked and inset between ends of case. Specify Pull.
Cabinet top is inset between ends.

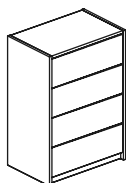

EQ-ST-TI-...-4LF

Four LF,	EQ-ST-TI-243053-4LF	24	30	53	288	2321
top inset	EQ-ST-TI-243653-4LF	24	36	53	301	2321

Four lateral file drawers are locked and inset between ends of case. Specify Pull.
Cabinet top is inset between ends.

*Equations Standard qualifies for MAGNA NOW! 10 day shipping program except for models with glass doors.

You must specify MAGNA NOW! on your purchase order. For large orders, please check with Customer Service to verify leadtime.

EQUATIONS - Component Pricing

Description	Model	Dimensions			Wgt	List Prices WoodPlus Edge
		Deep	Long	High		

Two lateral file drawers below

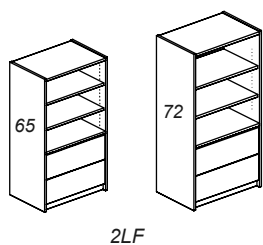

65 high	EQ-ST-TI-243065-2LF	24	30	65	274	2198
open above	EQ-ST-TI-243665-2LF	24	36	65	284	2256

Two lateral file drawers are locked and are inset between tower ends. Specify Pull.
Overall height matches standard height hutch.

72 high	EQ-ST-TI-243072-2LF	24	30	72	310	2198
open above	EQ-ST-TI-243672-2LF	24	36	72	322	2256

Two lateral file drawers are locked and are inset between tower ends. Specify Pull.
Overall height matches extended height hutch.

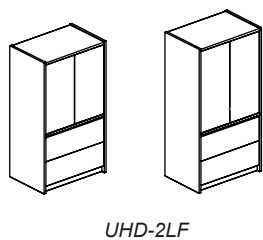

65 high	EQ-ST-TI-243065-UHD-2LF	24	30	65	295	2550
hinged doors	EQ-ST-TI-243665-UHD-2LF	24	36	65	305	2608

Two lateral file drawers are locked and are inset between tower ends. Specify Pull.
Upper hinged doors are inset between tower ends.
Overall height matches standard height hutch.

72 high	EQ-ST-TI-243072-UHD-2LF	24	30	72	331	2989
hinged doors	EQ-ST-TI-243672-UHD-2LF	24	36	72	343	2608
	OPTION-LOCK-UHD				87	87

Two lateral file drawers are locked and are inset between tower ends. Specify Pull.
Upper hinged doors are inset between tower ends.
Overall height matches extended height hutch.

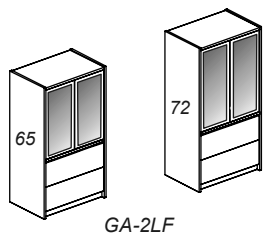

65 high	EQ-ST-TI-243065-GA-2LF	24	30	65	295	2989
Glass with aluminum	EQ-ST-TI-243665-GA-2LF	24	36	65	305	3047

Two lateral file drawers are locked and are inset between tower ends. Specify Pull.
Upper glass doors with aluminum frames are inset between tower ends. Pulls and locks are not available on Glass doors.
Overall height matches standard height hutch.

72 high	EQ-ST-TI-243072-GA-2LF	24	30	72	331	2989
Glass with aluminum	EQ-ST-TI-243672-GA-2LF	24	36	72	343	3047

Two lateral file drawers are locked and are inset between tower ends. Specify Pull.
Upper glass doors with aluminum frames are inset between tower ends. Pulls and Locks are not available on Glass doors.
Overall height matches extended height hutch.

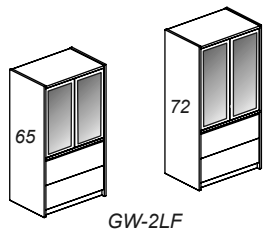

65 high	EQ-ST-TI-243065-GW-2LF	24	30	65	295	2989
Glass with WoodPlus2 frames	EQ-ST-TI-243665-GW-2LF	24	36	65	305	3047

Two lateral file drawers are locked and are inset between tower ends. Specify Pull.
Upper glass doors with WoodPlus2 frames are inset between tower ends.
GA or GW doors use frosted glass.
For clear glass, please add List \$210 per unit and '-CLEAR' to model name.
Pulls and locks are not available on Glass doors.
Overall height matches standard height hutch.

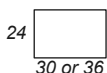

72 high	EQ-ST-TI-243072-GW-2LF	24	30	72	331	2989
Glass with WoodPlus2 frames	EQ-ST-TI-243672-GW-2LF	24	36	72	343	3047

Two lateral file drawers are locked and are inset between tower ends. Specify Pull.
Upper glass doors with WoodPlus2 frames are inset between tower ends.
GA or GW doors use frosted glass.
For clear glass, please add List \$210 per unit and '-CLEAR' to model name.
Pulls and Locks are not available on Glass. Overall height matches extended height hutch.

***Equations Standard qualifies for MAGNA NOW! 10 day shipping program except for models with glass doors.**

You must specify MAGNA NOW! on your purchase order. For large orders, please check with Customer Service to verify leadtime.

EQUATIONS - Component Pricing

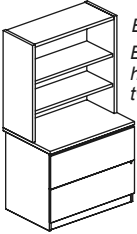
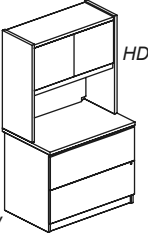
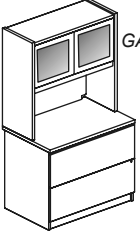
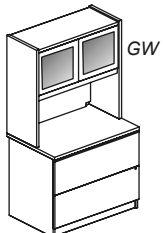
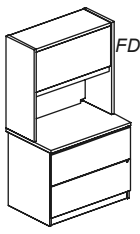
Description	Model	Dimensions			Wgt	List Prices WoodPlus Edge	
		Deep	Long	High			
Lateral File drawers with hutch storage above							
	Open	EQ-HL-TI-243065-BS-2LF	24	30	65	248	2135
	65 high	EQ-HL-TI-243665-BS-2LF	24	36	65	260	2138
Overall height matches extended height hutch or bookcase at 65 high.							
	Open	EQ-HL-TI-243072-BS-2LF	24	30	72	248	2177
	72 high	EQ-HL-TI-243672-BS-2LF	24	36	72	260	2180
Two lateral file drawers are locked. Specify Pull. Bookshelf hutch has two adjustable shelves (no fixed shelf). Overall height matches extended height hutch or bookcase at 72 high.							
	Hinged Doors	EQ-HL-TI-243065-HD-2LF	24	30	65	248	2414
	65 high	EQ-HL-TI-243665-HD-2LF	24	36	65	260	2417
					OPTION-LOCK-PAIR-DOORS	87	87
Overall height matches extended height hutch or bookcase at 65 high.							
	Hinged Doors	EQ-HL-TI-243072-HD-2LF	24	30	72	248	2457
	72 high	EQ-HL-TI-243672-HD-2LF	24	36	72	260	2460
					OPTION-LOCK-PAIR-DOORS	0	87
Two lateral file drawers are locked. Hutch has hinged doors. Specify Pull. Overall height matches extended height hutch or bookcase at 72 high.							
	GA glass doors	EQ-HL-TI-243065-GA-2LF	24	30	65	293	2823
	65 high	EQ-HL-TI-243665-GA-2LF	24	36	65	260	2855
Overall height matches extended height hutch or bookcase at 65 high.							
	GA glass doors	EQ-HL-TI-243072-GA-2LF	24	30	72	293	2866
	72 high	EQ-HL-TI-243672-GA-2LF	24	36	72	260	2896
Two lateral file drawers are locked. Specify Pull. Hutch has glass doors with aluminum frame. Locks and Pulls are not available on glass doors. GA or GW doors use frosted glass. For clear glass, please add List \$210 per unit and '-CLEAR' to model name. Overall height matches extended height hutch or bookcase at 72 high.							
	GW glass doors	EQ-HL-TI-243065-GW-2LF	24	30	65	293	2823
	65 high	EQ-HL-TI-243665-GW-2LF	24	36	65	260	2855
Overall height matches extended height hutch or bookcase at 65 high.							
	GW glass doors	EQ-HL-TI-243072-GW-2LF	24	30	72	293	2866
	72 high	EQ-HL-TI-243672-GW-2LF	24	36	72	260	2896
Two lateral file drawers are locked. Specify Pull. Hutch has glass doors with WoodPlus frame. Locks and Pulls are not available on glass doors. GA or GW doors use frosted glass. For clear glass, please add List \$210 per unit and '-CLEAR' to model name. Overall height matches extended height hutch or bookcase at 72 high.							
	Flipper Doors	EQ-HL-TI-243065-FD-2LF	24	30	65	248	2414
	65 high	EQ-HL-TI-243665-FD-2LF	24	36	65	260	2417
					OPTION-LOCK-FLIPPER-DOOR	87	87
Overall height matches extended height hutch or bookcase at 65 high.							
	Flipper Doors	EQ-HL-TI-243072-FD-2LF	24	30	72	248	2457
	72 high	EQ-HL-TI-243672-FD-2LF	24	36	72	260	2460
					OPTION-LOCK-FLIPPER-DOOR	0	87
Two lateral file drawers are locked. Specify Pull. Hutch has flipper door. Overall height matches extended height hutch or bookcase at 72 high.							

*Equations Standard qualifies for MAGNA NOW! 10 day shipping program except for models with glass doors.

You must specify MAGNA NOW! on your purchase order. For large orders, please check with Customer Service to verify leadtime.

EQUATIONS - Component Pricing

Description	Model	Dimensions			Wgt	List Prices <small>WoodPlus Edge</small>
		Deep	Long	High		

Bookcases

Bookcases

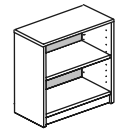

EQ-ST-TO-153029-BCK

Worktop, black back	EQ-ST-TO-153042-BCK	15	30	29	89	839
Cabinet top over matches worktop finish and detailing.						

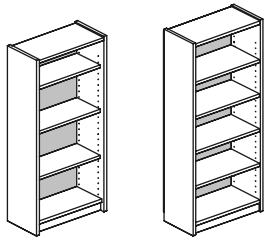

EQ-ST-TI-...BCK

Top inset, black back	EQ-ST-TI-153036-BCK	15	30	36	98	733
	EQ-ST-TI-153042-BCK	15	30	42	108	760
	EQ-ST-TI-153048-BCK	15	30	48	125	786
	EQ-ST-TI-153060-BCK	15	30	60	140	813
	EQ-ST-TI-153065-BCK	15	30	65	156	839
	EQ-ST-TI-153072-BCK	15	30	72	156	885
	EQ-ST-TI-153084-BCK	15	30	84	212	930
	Cabinet top is inset between ends. Cabinet top finish matches case finish.					

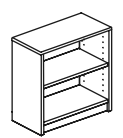

EQ-ST-TO-153029-BCB

Worktop, finished back	EQ-ST-TO-153029-BCB	15	30	29	89	886
Cabinet top over matches worktop finish and detailing.						

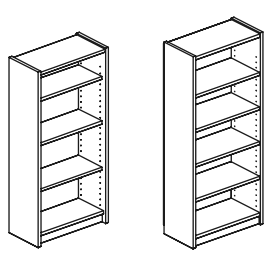

EQ-ST-TO-...BCB

Top inset, finished back	EQ-ST-TI-153036-BCB	15	30	36	98	780
	EQ-ST-TI-153042-BCB	15	30	42	108	840
	EQ-ST-TI-153048-BCB	15	30	48	125	901
	EQ-ST-TI-153060-BCB	15	30	60	140	961
	EQ-ST-TI-153065-BCB	15	30	65	156	1026
	EQ-ST-TI-153072-BCB	15	30	72	203	1071
	EQ-ST-TI-153084-BCB	15	30	84	212	1117
	Cabinet top is inset between ends. Cabinet top finish matches case finish.					

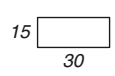

NOTES:

- 29 high matches worktop height.
- 29 high includes one adjustable shelf (does not accommodate two rows of binders)
- 36 high includes one adjustable shelf.
- 42, 48 high includes two adjustable shelves.
- 60, 65 high includes three adjustable shelves.
- 72 includes four adjustable shelves.
- 84 includes five adjustable shelves.

Adjustable shelves are 13 1/2" deep. Weight limit is 100 lbs per shelf.

36" wide bookcases are available at the same price, change the 30 to 36 in the model number.

Optional Extra Shelf	ESH-WPE					57
	ESH-STD					

***Equations Standard qualifies for MAGNA NOW! 10 day shipping program except for models with glass doors.**

You must specify MAGNA NOW! on your purchase order. For large orders, please check with Customer Service to verify leadtime.

EQUATIONS - Component Pricing

Description	Model	Dimensions			Wgt	List Prices WoodPlus Edge
		Deep	Long	High		

Storage Towers

65" and 72" high
Storage Towers

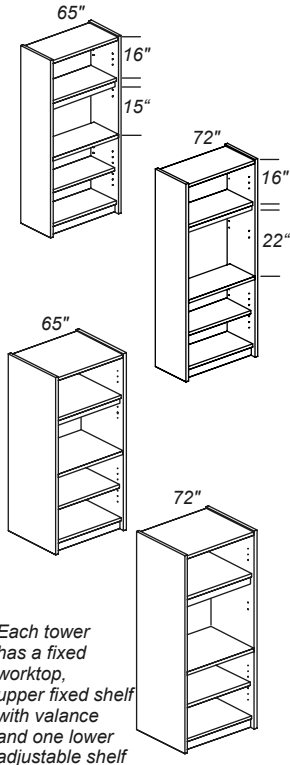

65 high 15 deep	EQ-ST-TI-153065	15	30	65	175	1061
	EQ-ST-TI-153665	15	36	65	194	1105
Fixed worktop with adjustable shelf below. Fixed upper shelf. Upper fixed shelf matches standard height hutch fixed shelf.						
72 high 15 deep	EQ-ST-TI-153072	15	30	72	188	1113
	EQ-ST-TI-153672	15	36	72	215	1157
Fixed worktop with adjustable shelf below. Fixed upper shelf. Upper fixed shelf matches extended height hutch fixed shelf.						
65 high 24 deep	EQ-ST-TI-243065	24	36	65	267	1186
	EQ-ST-TI-243665	24	36	65	267	1161
Fixed worktop with adjustable shelf below. Fixed upper shelf. Upper fixed shelf matches standard height hutch fixed shelf.						
72 high 24 deep	EQ-ST-TI-243072	24	30	72	260	1238
	EQ-ST-TI-243672	24	36	72	286	1282
Fixed worktop with adjustable shelf below. Fixed upper shelf. Upper fixed shelf matches extended height hutch fixed shelf.						

Options	OPTION-LHD	353
	OPTION-LHD-LOCKED	440
	OPTION-UHD	353
	OPTION-UHD-LOCKED	440
	OPTION-GA	791
	OPTION-GW	791
	OPTION-TACKBOARD-FPI	222

Add '-LHD' to model number to add Lower Hinged Doors (unlocked). Specify Pull.
 Add '-LHDL' to model number to add locked Lower Hinged Doors.
 Add '-UHD' to model number to add Upper Hinged Doors (unlocked). Specify Pull.
 Add '-UHDL' to model number to add locked Upper Hinged Doors.
 Add '-GA' to model number to add Upper Glass Doors with Aluminum frames (unlocked).
 Add '-GW' to model number to add Upper Glass Doors with WoodPlus frames (unlocked).
 GW glass doors with WoodPlus2 frame. Specify a current WoodPlus2 finish for the door frame.
 GA or GW doors use frosted glass.
 For clear glass, please add List \$210 per unit and '-CLEAR' to model name.

Add '-FPI' to model number to add tackboard between worktop and fixed upper shelf.
 Add '-ESH WPE' to model number to add an extra shelf to a tower.

Optional doors, tackboard

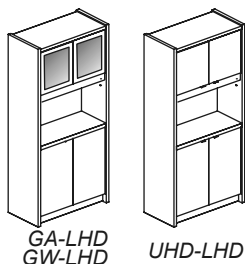
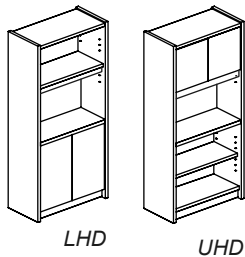

*Equations Standard qualifies for MAGNA NOW! 10 day shipping program except for models with glass doors.

You must specify MAGNA NOW! on your purchase order. For large orders, please check with Customer Service to verify leadtime.

EQUATIONS - Component Pricing

Description	Model	Dimensions			Wgt	List Prices WoodPlus Edge
		Deep	Long	High		

AV Storage Towers

AV Storage Towers

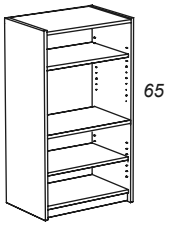

65 high	EQ-STV-TI-243065	24	30	65	276	1334
	EQ-STV-TI-243665	24	36	65	301	1392

Matches standard height hutch and 65 high bookcases and towers.
Includes a GRVB vertical grommet center in the back, below the worktop.

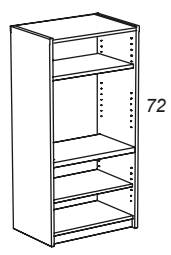

72 high	EQ-STV-TI-243072	24	30	72	312	1383
	EQ-STV-TI-243672	24	36	72	339	1439

Matches extended height hutch and 72 high bookcases and towers.
Includes a GRVB vertical grommet center in the back, below the worktop.

Options

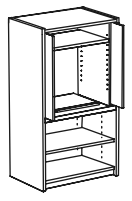

Upper Pocket Doors	EQ-STV-UPD	89				1001
---------------------------	-------------------	----	--	--	--	-------------

Pocket Doors slide into cabinet when open, and extend from worksurface to top of cabinet. Doors are inset below top and between ends. To order, add '-UPD' to model and specify pull number.

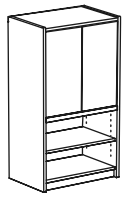

Upper Hinged Doors	EQ-STV-UHD	33				353
---------------------------	-------------------	----	--	--	--	------------

Upper Hinged Doors use 165 degree hinges and extend from worksurface to top of cabinet. Doors are inset below top and between ends. To order, add '-UHD' to model and specify pull number.

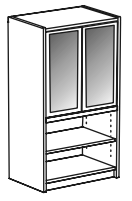

Glass Doors with Aluminum frame	EQ-STV-UGA	45				791
--	-------------------	----	--	--	--	------------

Upper Glass Doors use 165 degree hinges and extend from worksurface to top of cabinet. Doors are inset below top and between ends. To order, add '-GA' to model (no pull or lock on Glass doors). GA or GW doors use frosted glass. For clear glass, please add List \$210 per unit and '-CLEAR' to model name.

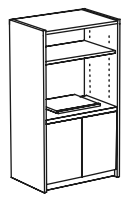

Glass Doors with WoodPlus2 frame	EQ-STV-UGW	45				791
---	-------------------	----	--	--	--	------------

Upper Glass Doors use 165 degree hinges and extend from worksurface to top of cabinet. Doors are inset below top and between ends. To order, add '-GW' to model (no pull or lock on Glass doors). GA or GW doors use frosted glass. For clear glass, please add List \$210 per unit and '-CLEAR' to model name.

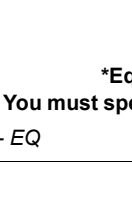

Lower Hinged Doors	EQ-STV-LHD	25				353
---------------------------	-------------------	----	--	--	--	------------

Lower Hinged Doors use 105 degree hinges. Doors are inset below fixed top at worktop height and between ends. To order, add '-LHD' to model and specify pull number.

Vertical Grommet	VERTICAL-GROMMET-BACK				48
	VERTICAL-GROMMET-LEFT-END				48
	VERTICAL-GROMMET-RIGHT-END				48
	LOCK for a pair of UHD hinged doors, UPD pocket doors, LHD lower hinged doors				87

***Equations Standard qualifies for MAGNA NOW! 10 day shipping program except for models with glass doors.**

You must specify MAGNA NOW! on your purchase order. For large orders, please check with Customer Service to verify leadtime.

EQUATIONS - Component Pricing

Description Model Dimensions Deep Long High Wgt List Prices
WoodPlus Edge

TV pull out tray for AV tower

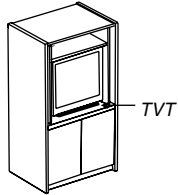

Pull out tray TVT 18 30 592

Finish is Black.
To order as Accessory, use model number TVT-30 for 30 wide towers or TVT-36 for 36 wide towers.
To order as Option mounted on worksurface, add '-TVT-WS' to model number.

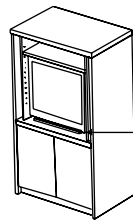

Clearance for TV

Cabinet Width	Open - No Doors			Hinged or Pocket Doors		
	W	H	D	W	H	D
30"	27-3/4	23-5/8*	22	22-1/4	23-5/8*	21-1/8
36"	33-3/4	23-5/8*	22	28-1/4	23-5/8*	21-1/8

65" or 72" on Worksurface

*with TVT Tray - 25-3/8 without TVT

TV Tray Location

Reception Desks

Reception Desk

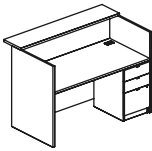

Transaction top over	EQ-RD-TO-364243-BBF	37	44	43	269	2710
	EQ-RD-TO-364843-BBF	37	50	43	284	2944
	EQ-RD-TO-366043-BBF	37	62	43	314	3036
	EQ-RD-TO-367243-BBF	37	74	43	344	3191

Worktop includes two grommets, one in each back corner.
BBF pedestal with lock is included. Specify pull number.

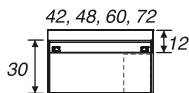

Bow front transaction top	EQ-RD-BTO-364243-BBF	40	44	43	269	2853
	EQ-RD-BTO-364843-BBF	40	50	43	284	3086
	EQ-RD-BTO-366043-BBF	40	62	43	314	3178
	EQ-RD-BTO-367243-BBF	40	74	43	344	3333

Worktop includes two grommets, one in each back corner.
BBF pedestal with lock is included. Specify pull number.

Reception Desk Bow Front Counter

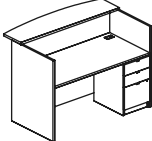

WoodPlus2 transaction top **OPTION-T-TOP-WP2** 73

Add -TT2 to model number to order an optional WoodPlus2 rectangular transaction top to a reception desk, or -TB2 to order a WoodPlus2 Bow front top.

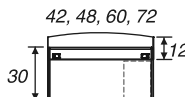

*Equations Standard qualifies for MAGNA NOW! 10 day shipping program except for models with glass doors.

You must specify MAGNA NOW! on your purchase order. For large orders, please check with Customer Service to verify leadtime.



Equations Component Parts layout procedures

Step 1: Layout what you want

This layout should include the following:

- TOPS
- LOWER STORAGE
- HUTCHES, WALL MOUNTED OVERHEADS
- MODESTY PANELS, as desired
- BOOKCASES, LATERAL FILES, TACKBOARDS, ETC.

Step 1 examples:

30 x 72" Top with
Single Storage Pedestal

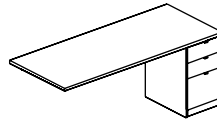

30 x 72" Radius End Desk
48" Return with Storage Pedestal
Hutch Spanning Return & Desk

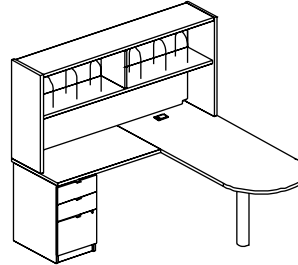
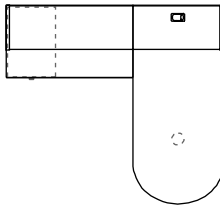

U shape unit with 30 x 72" Desk
48" Bridge and 24 x 72" Credenza
Flipper Door Wall Mount Overheads

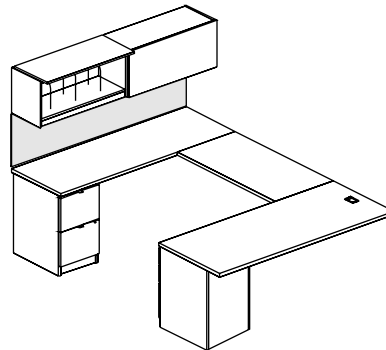
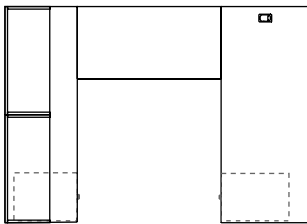

Then, use the next two steps to complete the assembly, build in structural stability and create a complete list of necessary components.

*Equations Standard qualifies for MAGNA NOW! 10 day shipping program, except for models with glass doors.

You must specify MAGNA NOW! on your purchase order. For large orders, please check with Customer Service to verify leadtime.



Equations Component Parts layout procedures

Step 2: Support both ends of every hutch and every top

2A: Each HUTCH needs support directly below each end.

Pedestal, Lateral File, End Panel MUST match the depth of the top when a hutch is placed on top. Hutches NOT available on 36" deep tops.

The following components can be used to support a hutch end

- Pedestal (EQ-PED-...)
Lateral File (2 drawer EQ-CAB-LF....)
- Door Storage or Open Storage
- End Panel
- Modesty Panel

2B: Each end of DESK and CREDENZA top requires support directly below it.

One of the DESK top or CREDENZA top ends MUST have one of the following:

- Lower Storage
- Corner Assembly
- Adjacent Bookcase or Lateral File

The other end of the DESK top or CREDENZA top may have any of the above support items or

- End Panel

Note that if supporting a hutch placed above end panels at both ends of a DESK or CREDENZA top, then one of the end panels must be removed and either LOWER STORAGE, BOOKCASE or LATERAL FILE must support one end of this top.

2C: Each end of BRIDGE and RETURN top requires support.

Any of the following can support either, or both, ends of a BRIDGE or RETURN top.

- Lower Storage
- Corner Assembly
- Adjacent Bookcase or Lateral File
- End Panel
- Top connecting hardware such as Splice Plate Ovals or Splice Plate Oval with Angle Bracket

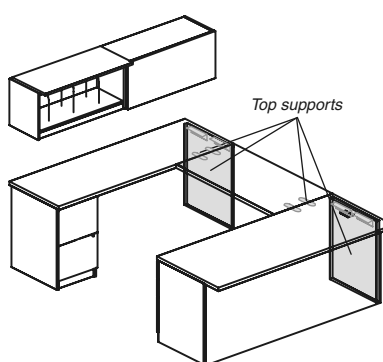
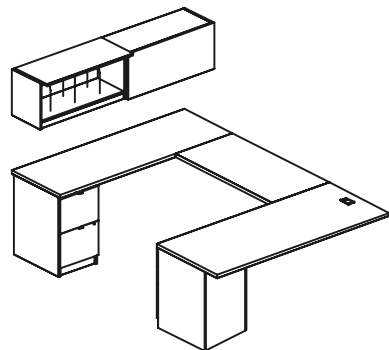
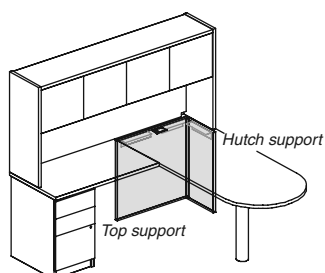
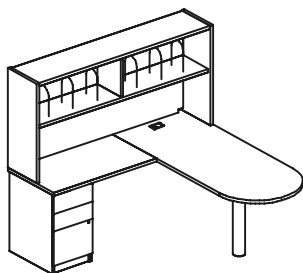

*Equations Standard qualifies for MAGNA NOW! 10 day shipping program, except for models with glass doors.

You must specify MAGNA NOW! on your purchase order. For large orders, please check with Customer Service to verify leadtime.



Equations Component Parts layout procedures

Step 3: Check the top SPAN for length and add additional support as needed

3A: Spans less than 42" require NO additional support

- Modesty Panels may be used, but are not required.

3B: Spans over 42" but less than 56" require the addition of one of the following:

- EQ-TOP-RAIL (matches top length)
- Modesty Panel (matches top length)
- End Panel placed mid-span

Spans over 56" require the addition of either of the following:

- Modesty Panel (matches top length)
- End Panel placed mid-span

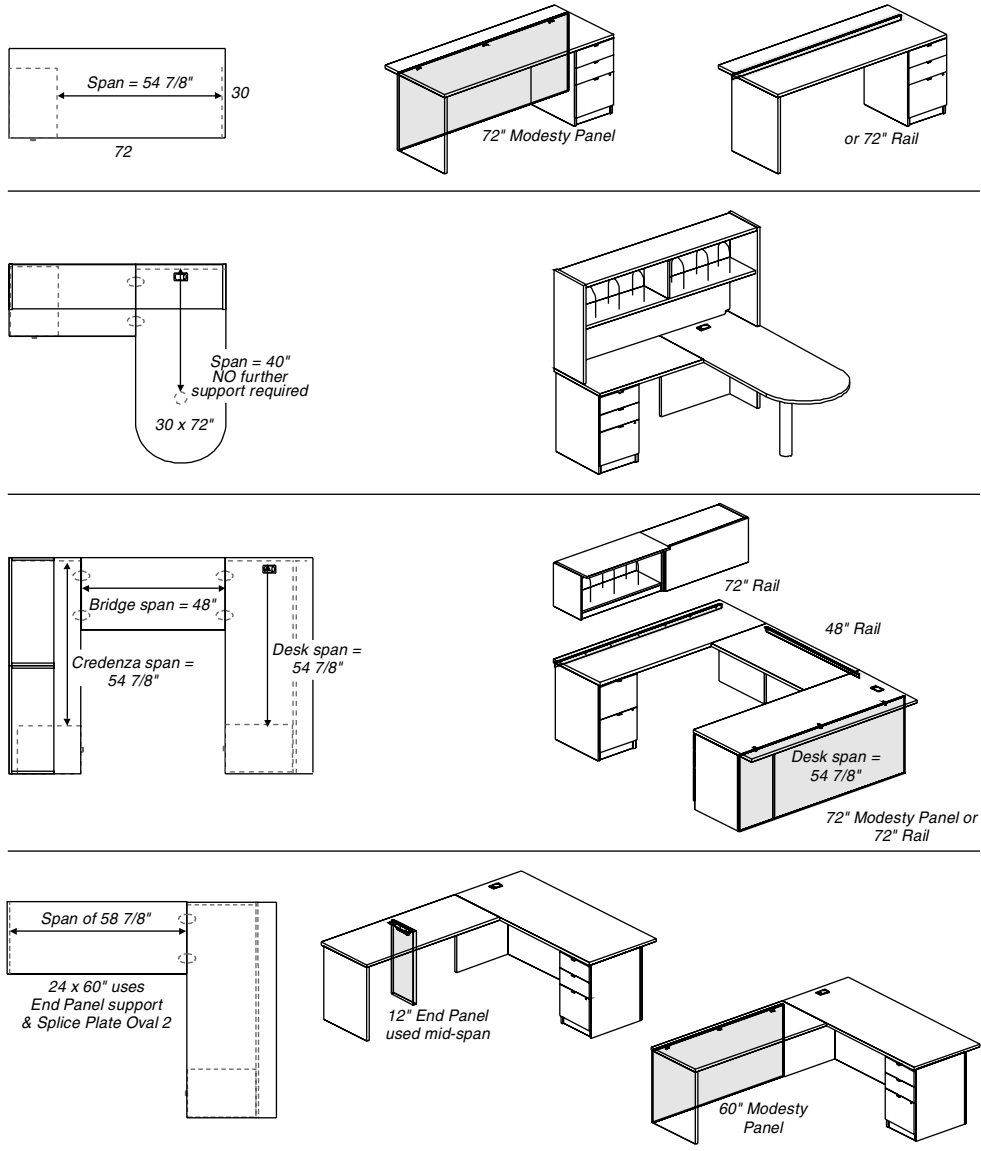



***Equations Standard qualifies for MAGNA NOW! 10 day shipping program, except for models with glass doors.**

You must specify MAGNA NOW! on your purchase order. For large orders, please check with Customer Service to verify leadtime.

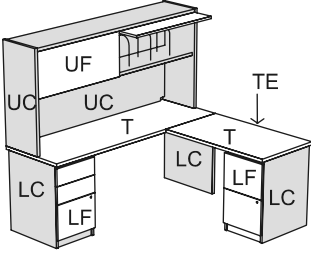

Equations Component Parts layout procedures

Step 4: Answer the Specification questions:

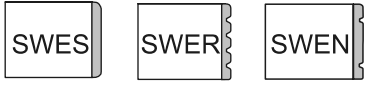
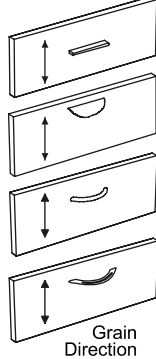
<p>Please Specify:</p> <p><u>for Worktops</u> T - Worktop finish - Top Edge profile TE - Top Edge finish</p> <p><u>for Lowers</u> LC - Cabinet case, Modesty Panels, End Panels finish LF - lower face finish - Pull number</p> <p><u>for Hutches/Overheads</u> UC - Top, ends and back finish UF - upper doors, tower doors finish - Pull number</p> 	<p>Available Finishes:</p> <p><u>FOR ALL SURFACES</u></p> <p><u>WoodPlus</u> WP41 Natural Maple WP81 Fusion Maple WP04 Solar Oak WP45 Anigre WP61 Pear WP31 Medium Cherry WP71 Dark Cherry WP73 Cognac WP48 Sipping Seattle Java WP23 Cordovan</p> <p><u>WoodPlus XTRA*</u> WP05 Rift Oak WP35 Golden Cherry (2) WP75 Chestnut WP33 Blossom Cherry WP37 Mocha Cherry (2) WP67 Chocolate Pear (2) WP15 Midnight (1)</p> <p>*XTRA Add \$600 per finish per order</p> <p>(1) use complimentary CP-76 Espresso 3mm PVC edge (2) matching PVC edge is not currently available</p> <p><u>FOR ANY SURFACE EXCEPT WORKTOPS</u></p> <p>CP88 Black CP76 Espresso CP98 Slate</p> <p><u>COLUMN SUPPORTS</u></p> <p>P1 Black P8 Silver</p>	<p>Worktop Edge Profiles:</p> <p>WoodPlus 3mm PVC edge for worktops</p>  <p>Smooth Reeded NeoClassic</p> <p>Standard wood 3mm edge for worktops - add \$100 List for each worktop</p>  <p>Smooth Reeded NeoClassic</p> <p>WoodPlus PVC edge for hutches, end panels, flipper doors is always EQS (smooth).</p> <p>Pull Style Numbers:</p>  <p>#10 Black Chrome #12 Black #13 Satin Chrome #14 Black #15 Satin Chrome #18 Black #19 Satin Chrome #14, 15, 18 & 19 are ADA compliant</p> <p>Grain Direction</p>
---	--	---

Magna Now fabrics

The following Guilford fabrics are available for MagnaNOW!

- 101) 2823-014 Hopstotch, Tictactoe (Gray)
- 102) 3548-040 Raku, Prism (Tan/taupe)
- 103) 3548-020 Raku, Porcelain (Tan/taupe & Gray)
- 104) 2100-380 FR701, Quartz (Tan/taupe)
- 105) 2818-010 Orissa, Kashmir (Tan/wheat)
- 106) 3548-060 Raku, Bottle (Green)
- 107) 2100-380 FR701 Rose Quartz (Rose)
- 108) 4052-053 Belgrade, Bluehill (Blue)

Most standard Guilford Panel Fabrics are available on MagnaFLEX lead time.*

If the fabric is not shown in our current specifications, see www.magnadesign.com, please contact factory for Fabric Grade, availability, lead time and pricing.

Pricing shown is for Magna designated Fabric Grades A, B, C.

For COM fabric, please use the pricing shown above.

A sample of the COM fabric plus the fabric specifications such as width of roll, directional or non-directional is required.

***Equations Standard qualifies for MAGNA NOW! 10 day shipping program, except for models with glass doors.**

You must specify MAGNA NOW! on your purchase order. For large orders, please check with Customer Service to verify leadtime.

EQUATIONS - Component Parts Pricing

Description Model Dimensions
Deep Long High Wgt  List Prices
WoodPlus Edge

Rectangle Worktops



5" deep	Model	Deep	Long	High	Wgt	List Prices
	EQ-TOP-TT-1524	15	24	1.125	12	186
	EQ-TOP-TT-1530	15	30	1.125	15	220
	EQ-TOP-TT-1536	15	36	1.125	18	238
	EQ-TOP-TT-1542	15	42	1.125	21	254
	EQ-TOP-TT-1548	15	48	1.125	24	265
	EQ-TOP-TT-1554	15	54	1.125	27	283
	EQ-TOP-TT-1560	15	60	1.125	30	303
	EQ-TOP-TT-1566	15	66	1.125	33	316
	EQ-TOP-TT-1572	15	72	1.125	36	331



4" deep	Model	Deep	Long	High	Wgt	List Prices
	EQ-TOP-TT-2416	24	16	1.125	19	199
	EQ-TOP-TT-2424	24	24	1.125	22	199
	EQ-TOP-TT-2430	24	30	1.125	24	235
	EQ-TOP-TT-2432	24	32	1.125	27	238
	EQ-TOP-TT-2436	24	36	1.125	29	238
	EQ-TOP-TT-2442	24	42	1.125	33	254
	EQ-TOP-TT-2448	24	48	1.125	38	265
	EQ-TOP-TT-2454	24	54	1.125	43	283
	EQ-TOP-TT-2460	24	60	1.125	48	303
	EQ-TOP-TT-2466	24	66	1.125	53	316
	EQ-TOP-TT-2472	24	72	1.125	57	331
	OPTION-GRE	48	3.5			48
	OPTION-GRE-GRE	1.75	3.5			96
	OPTION-GRC	1.75	3.5			48

Add '-GRE', '-GRE-GRE', or '-GRC' to model number to order the appropriate grommet(s) on the top.



3" deep	Model	Deep	Long	High	Wgt	List Prices
	EQ-TOP-TT-3016	30	16	1.125	16	235
	EQ-TOP-TT-3024	30	24	1.125	24	235
	EQ-TOP-TT-3030	30	30	1.125	30	250
	EQ-TOP-TT-3032	30	32	1.125	32	252
	EQ-TOP-TT-3036	30	36	1.125	36	252
	EQ-TOP-TT-3042	30	42	1.125	42	274
	EQ-TOP-TT-3048	30	48	1.125	48	290
	EQ-TOP-TT-3054	30	54	1.125	53	311
	EQ-TOP-TT-3060	30	60	1.125	59	345
	EQ-TOP-TT-3066	30	66	1.125	65	359
	EQ-TOP-TT-3072	30	72	1.125	71	374
	OPTION-GRE	1.75	3.5			48
	OPTION-GRE-GRE	1.75	3.5			96

Add '-GRE' or '-GRE-GRE' to model number to order the appropriate grommet(s) on the top.



6" deep	Model	Deep	Long	High	Wgt	List Prices
	EQ-TOP-TT-3672	36	72	1.125	86	418
	OPTION-GRE	1.75	3.5			48
	OPTION-GRE-GRE	1.75	3.5			96

Add '-GRE' or '-GRE-GRE' to model number to order the appropriate grommet(s) on the top.

***Equations Standard qualifies for MAGNA NOW! 10 day shipping program except for models with glass doors.**

You must specify MAGNA NOW! on your purchase order. For large orders, please check with Customer Service to verify leadtime.

EQUATIONS - Component Parts Pricing

Optional Grommets- Locations

Description	Model	Dimensions			Wgt	List Prices WoodPlus Edge
		Deep	Long	High		
24" Deep Tops						
	Lower storage below GRE blocks access to grommet.	Lower storage below GRE blocks access to grommet.	GRC is on user side of modesty panel when it is used.			
30" Deep Tops						
	Lower storage below GRE blocks access to grommet.	Lower storage below GRE blocks access to grommet.				
36" Deep Tops						
	Lower storage below GRE blocks access to grommet.	Lower storage below GRE blocks access to grommet.				

Bow Front Worktops



36 deep	EQ-TOP-BO-3666	36	66	1.125	80	559
	EQ-TOP-BO-3672	36	72	1.125	86	583
42 deep	EQ-TOP-BO-4266	42	66	1.125	95	659
	EQ-TOP-BO-4272	42	72	1.125	103	682

Options	OPTION-GREL	48
	OPTION-GRER	48

To order a worktop grommet to the LEFT of the user, add ' -GREL' to the model number .
To order a worktop grommet to the RIGHT of the user, add ' -GRER' to the model number .

Shark shaped Worktops

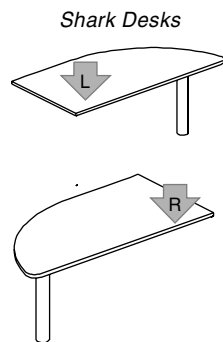

Left	EQ-TOP-SH-3660-C4-L	36	60	1.125	59	992
	EQ-TOP-SH-3666-C4-L	36	66	1.125	65	1027
	EQ-TOP-SH-3672-C4-L	36	72	1.125	71	1050
Right	EQ-TOP-SH-3660-C4-R	36	60	1.125	59	992
	EQ-TOP-SH-3666-C4-R	36	66	1.125	65	1027
	EQ-TOP-SH-3672-C4-R	36	72	1.125	71	1050

Option	OPTION-GRE	48
--------	------------	----

To order GRE grommet at ' flat end' of Shark top, add ' -GRE' to model number.

*Equations Standard qualifies for MAGNA NOW! 10 day shipping program except for models with glass doors.

You must specify MAGNA NOW! on your purchase order. For large orders, please check with Customer Service to verify leadtime.

EQUATIONS - Component Parts Pricing

Description	Model	Dimensions			Wgt	List Prices <small>WoodPlus Edge</small>
		Deep	Long	High		



Pedestals

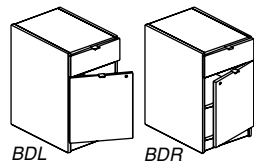
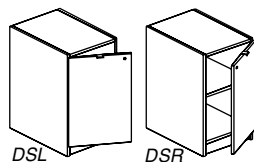
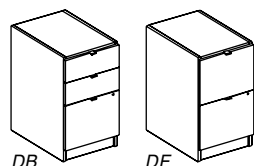

Pedestal Configurations

24" deep with Lock	EQ-PED-241629-BBF	22.75	16	27.5	82	813
	EQ-PED-241629-FF	22.75	16	27.5	82	813
	EQ-PED-241629-BDL	22.75	16	27.5	82	813
	EQ-PED-241629-BDR	22.75	16	27.5	82	813
	EQ-PED-241629-DSL	22.75	16	27.5	82	813
	EQ-PED-241629-DSR	22.75	16	27.5	82	813

Pedestals are for use under a worktop. Worktops must be ordered separately.
Specify Pulls.

30" deep with Lock	EQ-PED-301629-BBF	28.75	16	27.5	82	813
	EQ-PED-301629-FF	28.75	16	27.5	82	813
	EQ-PED-301629-BDL	28.75	16	27.5	82	813
	EQ-PED-301629-BDR	28.75	16	27.5	82	813
	EQ-PED-301629-DSL	28.75	16	27.5	82	813
	EQ-PED-301629-DSR	28.75	16	27.5	82	813

Pedestals are for use under a work top. Work top must be ordered separately.

Lateral File Cabinets

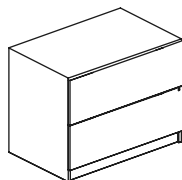

24" deep Lateral File	EQ-CAB-243029-LF	22.75	29.75	27.5	138	1181
	EQ-CAB-243629-LF	22.75	35.75	27.5	138	1181

Includes lock. Specify Pull.

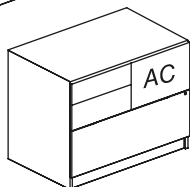

24" deep Combo cabinet	EQ-CAB-243229-AC	22.75	32	27.5	138	1181
	EQ-CAB-243229-BC	22.75	32	27.5	138	1181

Includes lock for Lateral File and File drawers only. Box drawers do not lock. Specify Pull.
COMBO-A has the two Box drawers on the top left of cabinet.
COMBO-B has the two Box drawers on the top right of the cabinet.

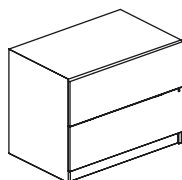

30" deep Lateral File	EQ-CAB-303029-LF	28.75	29.75	27.5	138	1181
	EQ-CAB-303629-LF	28.75	35.75	27.5	138	1181

Includes lock. Specify Pull.

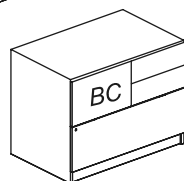

30" deep Combo cabinet	EQ-CAB-303229-AC	28.75	32	27.5	138	1181
	EQ-CAB-303229-BC	28.75	32	27.5	138	1181

Includes lock for Lateral File and File drawers only. Box drawers do not lock. Specify Pull.
COMBO-A has the two Box drawers on the top left of cabinet.
COMBO-B has the two Box drawers on the top right of the cabinet.

Cabinets are for use under a work top. Work top must be ordered separately.

***Equations Standard qualifies for MAGNA NOW! 10 day shipping program except for models with glass doors.**

You must specify MAGNA NOW! on your purchase order. For large orders, please check with Customer Service to verify leadtime.

EQUATIONS - Component Parts Pricing

Description	Model	Dimensions			Wgt	List Prices WoodPlus Edge
		Deep	Long	High		



Door Storage Cabinets

Door Storage cabinets

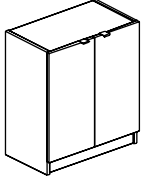

EQ-CAB-DS-...

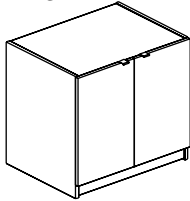

EQ-CAB-DS-...

All Door Storage 24, 30, 36 wide have one pair of doors

Door Storage 15" deep	EQ-CAB-152429-DS	13.75	23.75	27.5	69	746
	EQ-CAB-153029-DS	13.75	29.75	27.5	80	805
	EQ-CAB-153629-DS	13.75	35.75	27.5	93	805
	LOCK-PAIR-HINGED-DOORS					87
Specify Pull.						
Door Storage 24" deep	EQ-CAB-243029-DS	22.75	29.75	27.5	125	805
	EQ-CAB-243629-DS	22.75	35.75	27.5	138	805
	LOCK-PAIR-HINGED-DOORS					87
	Specify Pull.					
Door Storage for filled credenza	EQ-CAB-242829-DS	22.75	27.75	27.5	125	826
	EQ-CAB-243429-DS	22.75	33.75	27.5	152	805
	EQ-CAB-244029-DS	22.75	39.75	27.5	148	909
	LOCK-PAIR-HINGED-DOORS					87
For 24 deep credenza. Specify pull. Use EQ-CAB-DS-242829 to fill between two pedestals on 60 long credenza. Use EQ-CAB-DS-243429 to fill between two pedestals on 66 long credenza. Use EQ-CAB-DS-244029 to fill between two pedestals on 72 long credenza.						
Door Storage 30" deep	EQ-CAB-303029-DS	28.75	29.75	27.5	146	805
	EQ-CAB-303629-DS	28.75	35.75	27.5	159	805
	LOCK-PAIR-HINGED-DOORS					87
	Specify Pull.					
Door Storage for filled credenza	EQ-CAB-302829-DS	28.75	27.75	27.5	146	826
	EQ-CAB-303429-DS	28.75	33.75	27.5	159	805
	EQ-CAB-304029-DS	28.75	39.75	27.5	169	909
	LOCK-PAIR-HINGED-DOORS					87
For 30 deep credenza. Specify pull. Use EQ-CAB-DS-302829 to fill between two pedestals on 60 long credenza. Use EQ-CAB-DS-303429 to fill between two pedestals on 66 long credenza. Use EQ-CAB-DS-304029 to fill between two pedestals on 72 long credenza.						

Door Storage cabinets are for use under a work top. Work top must be ordered separately.

Open Storage Cabinets

Open Storage cabinets

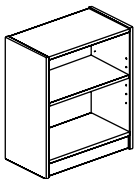

EQ-CAB-OS-...

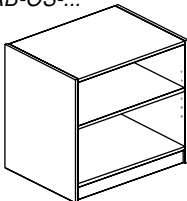

EQ-CAB-OS-...

Open Storage 15" deep	EQ-CAB-152429-OS	13.75	23.75	27.5	52	507
	EQ-CAB-153029-OS	13.75	29.75	27.5	52	507
	EQ-CAB-153629-OS	13.75	35.75	27.5	66	507
Open Storage 24" deep	EQ-CAB-243029-OS	22.75	29.75	27.5	71	568
	EQ-CAB-243629-OS	22.75	35.75	27.5	81	568
Open Storage 30" deep	EQ-CAB-303029-OS	28.75	29.75	27.5	81	624
	EQ-CAB-303629-OS	28.75	35.75	27.5	91	624

Open Storage cabinets are for use under a work top. Work top must be ordered separately.

*Equations Standard qualifies for MAGNA NOW! 10 day shipping program except for models with glass doors.

You must specify MAGNA NOW! on your purchase order. For large orders, please check with Customer Service to verify leadtime.

EQUATIONS - Component Parts Pricing

Description	Model	Dimensions			Wgt	List Prices <small>WoodPlus Edge</small>
		Deep	Long	High		



End Panels with mounting brackets

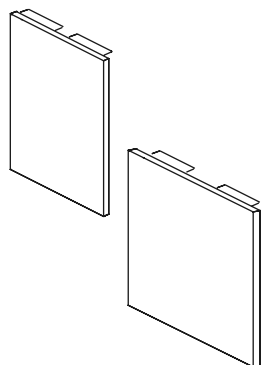

End panel includes mounting bracket(s)

with mounting bracket	EQ-EPB-1229	1.125	12	27.5	12	196
	EQ-EPB-1429	1.125	14	27.5	14	196
	EQ-EPB-1529	1.125	15	27.5	15	196
	EQ-EPB-2329	1.125	23	27.5	24	205
	EQ-EPB-2929	1.125	29	27.5	30	216

Modesty Panels

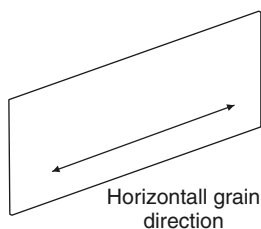

Horizontal grain	Model	Deep	Long	High	Wgt	List Price
	EQ-MP-2429-HORZ	0.75	24	27.5	15	168
	EQ-MP-3029-HORZ	0.75	30	27.5	17	168
	EQ-MP-3629-HORZ	0.75	36	27.5	21	168
	EQ-MP-4229-HORZ	0.75	42	27.5	24	168
	EQ-MP-4829-HORZ	0.75	48	27.5	28	168
	EQ-MP-6029-HORZ	0.75	60	27.5	35	168
	EQ-MP-6629-HORZ	0.75	66	27.5	39	168
	EQ-MP-7229-HORZ	0.75	72	27.5	42	168

Horizontal grain on modesty panel matches the grain direction of worksurfaces, backs of hutches, flipper doors. Available up to 72 long.

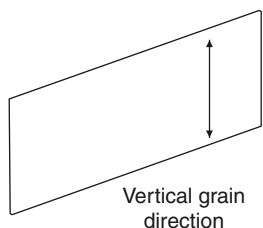

Vertical grain	Model	Deep	Long	High	Wgt	List Price
	EQ-MP-2429-VERT	0.75	24	27.5	15	168
	EQ-MP-3029-VERT	0.75	30	27.5	17	168
	EQ-MP-3629-VERT	0.75	36	27.5	21	168
	EQ-MP-4229-VERT	0.75	42	27.5	24	168
	EQ-MP-4829-VERT	0.75	48	27.5	28	168
	EQ-MP-5429-VERT	0.75	54	27.5	31	168
	EQ-MP-6029-VERT	0.75	60	27.5	35	168

Vertical grain on modesty panel matches the grain direction of end panels, drawer fronts, hinged doors, finished backs. Available up to 60 long.

***Equations Standard qualifies for MAGNA NOW! 10 day shipping program except for models with glass doors.**

You must specify MAGNA NOW! on your purchase order. For large orders, please check with Customer Service to verify leadtime.

EQUATIONS - Component Parts Pricing

Description	Model	Dimensions			Wgt	List Prices WoodPlus Edge
		Deep	Long	High		



Worktop Connectors

SPLICE-PLATE-OVAL-1

Splice Plate Oval	SPLICE-PLATE-OVAL-1	5	3	1	1	9
	SPLICE-PLATE-OVAL-2	5	3	1	2	18
	SPLICE-PLATE-OVAL-3	5	3	1	3	27

SPLICE-PLATE-OVAL-1 includes one each 3 x 5 worktop connecting bracket.
 SPLICE-PLATE-OVAL-2 includes two each 3 x 5 worktop connecting brackets.
 Use the SPLICE-PLATE-OVAL-2 to connect a 24 inch deep top.
 SPLICE-PLATE-OVAL-3 includes three each 3 x 5 worktop connecting brackets.
 Use the SPLICE-PLATE-OVAL-3 to connect a 30 or 36 inch deep top.

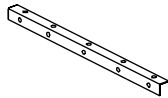

Angle Brackets	AB-8	8	1	1	2	15
-------------------	-------------	---	---	---	---	-----------

Use two AB-8 angle brackets on a 24" connection and three AB-8 angle brackets on a 30" or 36" connection.

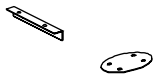

Splice Plate and Angle Bracket	SPL-AB	3	0	3	39	39
--------------------------------------	---------------	---	---	---	----	-----------

SPL-AB combines a single SPLICE-PLATE-OVAL and AB-8 angle bracket for use with recessed end panel.

Top support rails

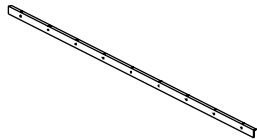

Top support rails	EQ-TOPRAIL-42	1	42	2	3	68
	EQ-TOPRAIL-48	1	48	2	3	71
	EQ-TOPRAIL-54	1	54	2	4	74
	EQ-TOPRAIL-60	1	60	2	4	74
	EQ-TOPRAIL-66	1	66	2	5	83
	EQ-TOPRAIL-72	1	72	2	5	83

Maximum top span without additional support is 42.
 For top span over 42 and up to 56, please use a top support rail, modesty panel or intermediate end panel.
 For top spans over 56, please use a modesty panel or intermediate end panel.

*Equations Standard qualifies for MAGNA NOW! 10 day shipping program except for models with glass doors.

You must specify MAGNA NOW! on your purchase order. For large orders, please check with Customer Service to verify leadtime.

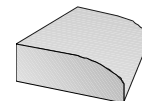

How to layout Equations² components

STEP 1: Layout Desks, Bridges, Returns, Credenzas, Overheads, Storage as needed using Equations² components.

STEP 2: Support both ends of every Hutch.
Both ends of Bridge top connect to adjacent desks, credenzas or corners
One end of Return top connects to the adjacent desk, credenza or corner.

EXAMPLES:

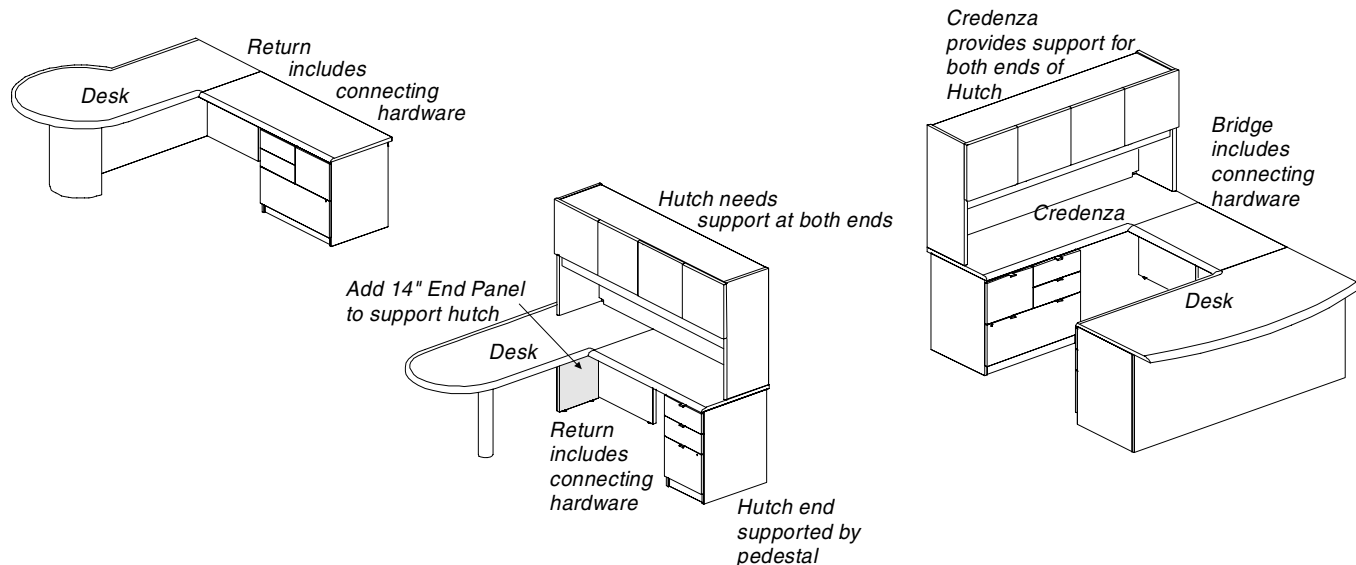

STEP 3: Answer the Specification questions for all components:

Please Specify:

for Worktops

T - Worktop finish

for Lower

LC - Cabinet case, Modesty Panels, End Panels finish
LF - Lower face finish
- Pull number

for Hutches/Overheads

UC - Top, ends and back finish
UF - Upper doors, Tower doors finish
Pull number

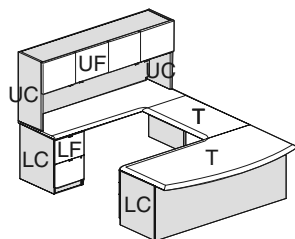

Available Finishes:

Worktops, Drawer & Door Faces:

WoodPlus²

WP2-45 Anigre
WP2-71 Dark Cherry
WP2-81 Fusion Maple
WP2-31 Medium Cherry
WP2-41 Natural Maple
WP2-61 Pear
WP2-23 Cordovan

ColorPlus²

CP2-28 Med. Gray Speckle
CP2-38 Beige Speckle

WoodPlus² XTRAS*

WP2-65 Beech
CP2-78 Bronze
CP2-74 Platinum
WP2-75 Port
WP2-18 Shadow Oak

*XTRA finishes add \$600 per finish per order

Cabinet Cases, Modesty Panels, End Panels, Hutch/Overhead Tops, ends and backs.

WoodPlus

WP-45 Anigre
WP-71 Dark Cherry
WP-81 Fusion Maple
WP-31 Medium Cherry
WP-41 Natural Maple
WP-61 Pear

ColorPlus

CP-76 Espresso
CP-88 Black
CP-98 Slate

Column Supports

P1 Black

P8 Silver

Pull Numbers:

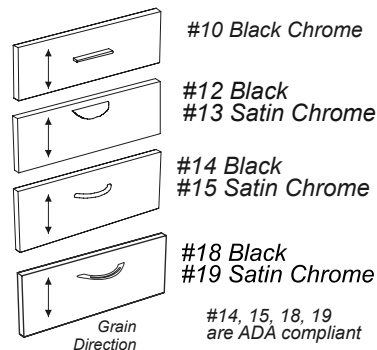

WoodPlus² work tops combine:

User edge

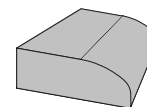

Joint and hutch edge

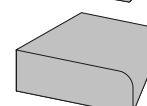

See drawings for details

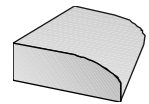

How to layout Equations² components

Equations² available grommet locations

Rectangular Desk worktops, 30" and 36" deep

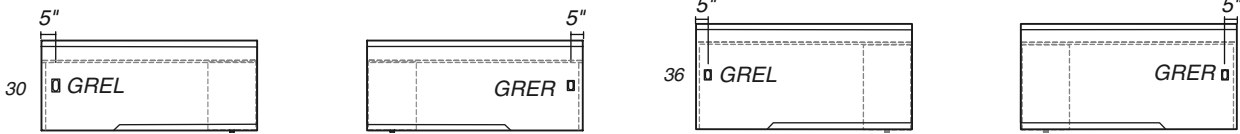

Bow Front Desk worktops

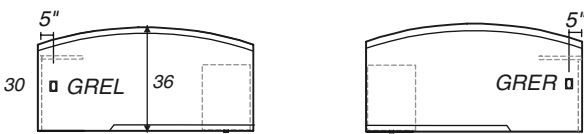

Radius end desk worktops

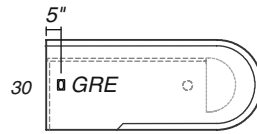

Keyhole Desk worktops

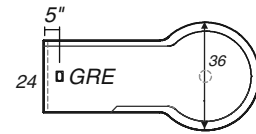

Angled Radius end worktops

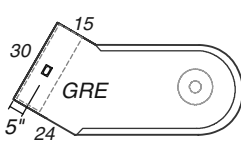

P Top Desk worktops

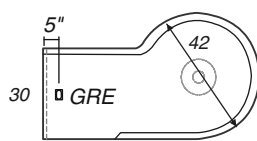

Shark Desk worktops

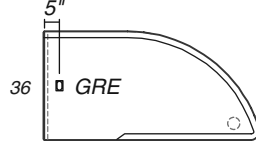

Corner Worktops, GRC included

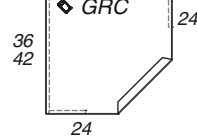

Rectangular Credenza worktops, 24" deep



Rectangular Return worktops, 24" deep

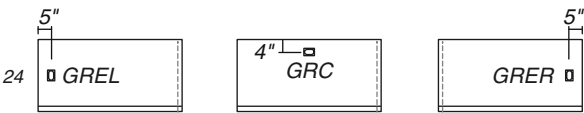

Rectangular Bridge worktops, 24" deep



Tapered Leg Option

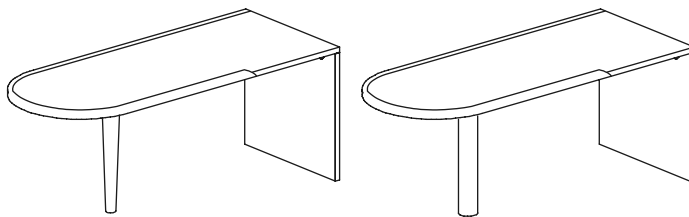

with Tapered Leg (optional)
To be connected to bridge or return

with 4" column base (default)
To be connected to bridge or return

Column Base Plate Option

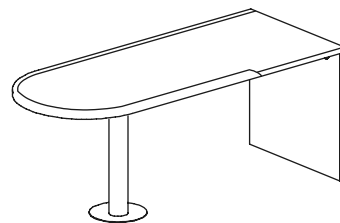

with Column Base Plate Option
Unit is to be freestanding desk

Equations²

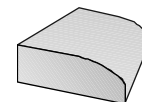

EQUATIONS² - Configuration Examples

Equations2 WoodPlus2 Configurations

WoodPlus² is a polymer material thermoformed under pressure and vacuum into a seamless, one-piece surface with an integrated edge.

Worktop edge combines

WoodPlus²

user edge

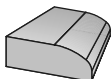

joint or hutch edge

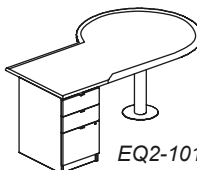
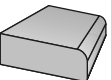

EQ2-101

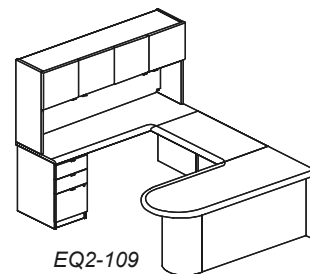

EQ2-109

Equations2 Configuration E2-101

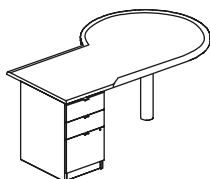

E2-101

E2-D-P-427229-BBF-C4-L	Desk with Box Box File pedestal	2193
		Total Price 2193

Equations2 Configuration E2-102

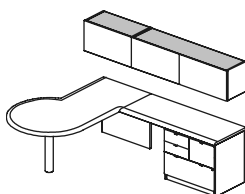

E2-102

E2-D-P-427229-C4-R	Desk	1552
E2-R-TT-246029-AC	Return with Combo-A cabinet	1792
E2-OW-156016-FDT	Overhead, wall mounted, flipper doors, 60 long	1174
E2-OW-153016-FDT	Overhead, wall mounted, flipper doors, 30 long	727
		Total Price 5245

Equations2 Configuration E2-103

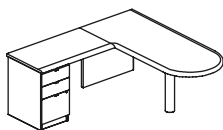

E2-103

E2-D-RE-307229-C4-L	Desk	1155
E2-R-TT-244229-BBF	Return with Box Box File pedestal	1251
		Total Price 2406

Equations2 Configuration E2-104

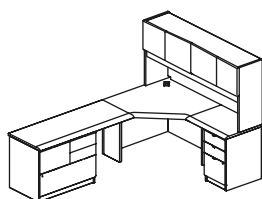

E2-104

E2-CNR-424229-24-R	Corner unit, with grain matching top to the right	1484
E2-R-TT-243029-BBF	Return with Box Box File pedestal	1144
E2-R-TT-246029-BC	Return with Combo B cabinet	1792
E2-H-TI-157235-HD	Hutch with hinged doors	1555
FPI-72L-35H	Hutch fabric panel	254
		Total Price 6229

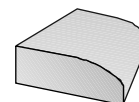

EQUATIONS² - Configuration Examples

Equations2 Configuration E2-105

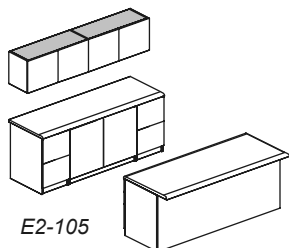

E2-105

E2-D-TT-367229-FF-MP-BBF	Desk with two pedestals and modesty panel	2858
E2-CR-TT-247229-FF-DS-FF	Credenza with two pedestals and door storage	3202
E2-OW-153616-HDT	Overhead, wall mounted, hinged doors,36 long	799
E2-OW-153616-HDT	Overhead, wall mounted, hinged doors,36 long	799
Total Price		7658

Equations2 Configuration E2-106

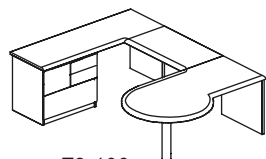

E2-106

E2-D-P-427229-C4-L	Desk	1552
E2-B-TT-244229	Bridge	410
E2-CR-TT-247229-BC-R	Credenza with Combo B cabinet	2089
Total Price		4051

Equations2 Configuration E2-107

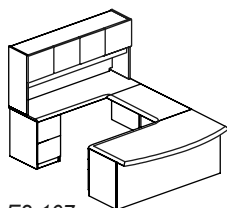

E2-107

E2-D-BO-367229-BBF-MP-L	Desk with Box Box File pedestal and modesty panel	2206
E2-B-TT-244229	Bridge	410
E2-CR-TT-247229-FF-R	Credenza with File File pedestal	1794
E2-H-TI-157242-HD	Hutch with hinged doors	1694
FPI-72L-42H	Hutch fabric panel	254
Total Price		6358

Equations2 Configuration E2-108

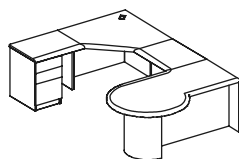

E2-108

E2-D-P-427229-MP-HC-L	Desk	2262
E2-B-TT-243029	Bridge	303
E2-CNR-424229-24-L	Corner unit with grain matching top to the left	1484
E2-R-TT-243029-BBF	Return with Box Box File pedestal	1144
Total Price		5193

Equations2 Configuration E2-109

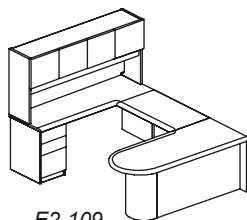

E2-109

E2-D-RE-307229-MP-HC-L	Desk	1862
E2-B-TT-244229	Bridge	410
E2-CR-TT-247229-BBF-R	Credenza with Box Box File pedestal	1794
E2-H-TI-157235-HD	Hutch with hinged doors	1555
FPI-72L-35H	Hutch fabric panel	254
Total Price		5875

EQUATIONS² - Component Overview

Radius End Desks

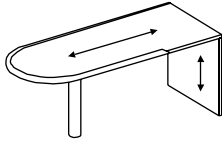

"E2 Radius End desk" on page 55

Angled Radius End Desk

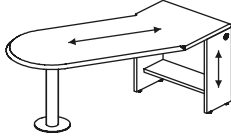

"Angled Radius End Desk, WoodPlus2" on page 56

Keyhole Desks

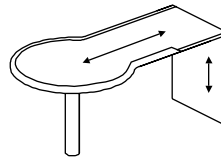

"E2 Keyhole desk" on page 56

P top Desks

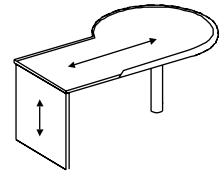

"E2 P desk" on page 57

Shark Desks

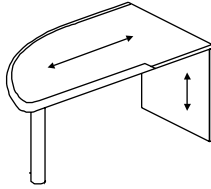

"E2 Shark desk" on page 58

Bow Front Desks

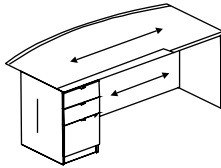

"E2 Bow front desk" on page 59

Rectangular Desks

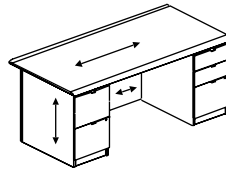

"E2 Rectangular desk" on page 60

Corner Component

Grain on top aligns with grain on left or right return.

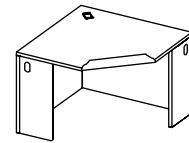

"E2 Corner" on page 61

Returns with Pedestal

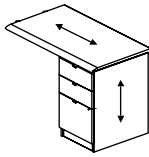

"E2 Return with pedestal" on page 62

Returns with Combo

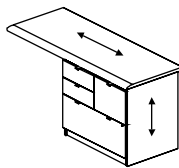

"E2 Return with Combo cabinet or Lateral File" on page 63

Bridge Tops

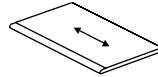

"E2 Bridge" on page 63

Filled credenza

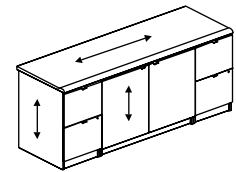

"E2 Credenza filled with pedestals, door storage" on page 66

Hutches

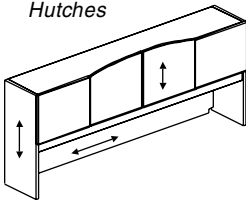

"E2 Hutches standard height -35- matches the height of 65" high storage tower" on page 67

Combination cabinet

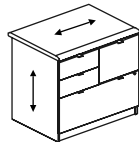

"Lateral File and Combo Components" on page 73

Lateral File and Hutch

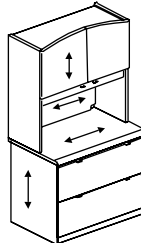

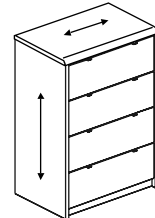

"Lateral File drawers with hutch storage above" on page 73

Lateral File tower

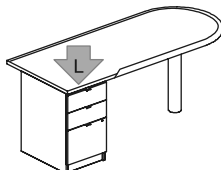
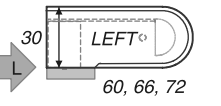
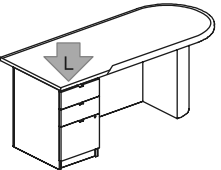

"E2 three and four drawer Lateral File cabinets" on page 74

EQUATIONS² - Component Pricing

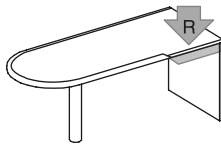
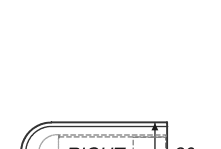
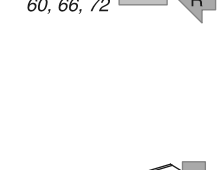
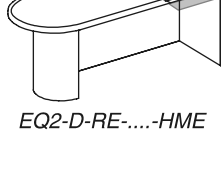
Description	Model	Dimensions			Wgt	List Prices WoodPlus ²	
		Deep	Long	High			
E2 Radius End desk							
 <p>Radius End Desks</p>	Column,	E2-D-RE-306029-BBF-C4-L	30	60	29	147	1688
	Pedestal	E2-D-RE-306629-BBF-C4-L	30	66	29	153	1743
	Left	E2-D-RE-307229-BBF-C4-L	30	72	29	159	1796
Radius End desk has column support and Box Box File pedestal with lock. Pedestal is to the LEFT of the user. Specify Pull.							
 <p>Radius End Desks</p>	Column,	E2-D-RE-306029-BBF-C4-R	30	60	29	147	1688
	Pedestal	E2-D-RE-306629-BBF-C4-R	30	66	29	153	1743
	Right	E2-D-RE-307229-BBF-C4-R	30	72	29	159	1796
Radius End desk has column support and Box Box File pedestal with lock. Pedestal is to the RIGHT of the user. Specify Pull.							
Option	OPTION-TAPERED-LEG						74
To order the Tapered Leg in place of the 4 inch column add ' -TL' to the model number							
 <p>Radius End Desks</p>	Modesty	E2-D-RE-306029-BBF-MP-HC-L	30	60	29	173	2396
	Panel,	E2-D-RE-306629-BBF-MP-HC-L	30	66	29	183	2450
	Pedestal	E2-D-RE-307229-BBF-MP-HC-L	30	72	29	192	2503
Radius End desk has modesty panel, half cylinder and Box Box File pedestal with lock. Pedestal is to the LEFT of the user. Specify Pull.							
 <p>Radius End Desks</p>	Modesty	E2-D-RE-306029-BBF-MP-HC-R	30	60	29	173	2396
	Panel,	E2-D-RE-306629-BBF-MP-HC-R	30	66	29	183	2450
	Pedestal	E2-D-RE-307229-BBF-MP-HC-R	30	72	29	192	2503
Radius End desk has modesty panel, half cylinder and Box Box File pedestal with lock. Pedestal is to the RIGHT of the user. Specify Pull.							
E2 RE desk, no pedestal, for L or U configuration							
 <p>Radius End Desks</p>	Column,	E2-D-RE-306029-C4-L	30	60	29	95	1047
	Return Left	E2-D-RE-306629-C4-L	30	66	29	101	1102
		E2-D-RE-307229-C4-L	30	72	29	107	1155
Radius End desk has column support. Connecting top is to the LEFT of the user.							
 <p>Radius End Desks</p>	Column,	E2-D-RE-306029-C4-R	30	60	29	95	1047
	Return Right	E2-D-RE-306629-C4-R	30	66	29	101	1102
		E2-D-RE-307229-C4-R	30	72	29	107	1155
Radius End desk has column support. Connecting top is to the RIGHT of the user.							
Options	OPTION-COLUMN-BASE-PLATE		12	12		8	68
	OPTION-TAPERED-LEG						74
	OPTION-GRE						48
This 12" diameter plate attaches to the bottom of the C4 column (not to the Tapered Leg). Required when this desk is freestanding (i.e. no bridge or return is connected to it). To order add ' -CBP' after the model number. To order the Tapered Leg in place of the C4 inch column add ' -TL' to the model number. With the Tapered Leg, the desk must be attached to return or bridge top. To order a worktop grummet at the ' flat' end of the desk add ' -GRE' to the model number .							
 <p>Radius End Desks</p>	Modesty	E2-D-RE-306029-MP-HC-L	30	60	29	121	1755
	Panel,	E2-D-RE-306629-MP-HC-L	30	66	29	131	1809
	Return Left	E2-D-RE-307229-MP-HC-L	30	72	29	140	1862
Radius End desk has modesty panel and half cylinder. Connecting top to the LEFT of the user.							
 <p>Radius End Desks</p>	Modesty	E2-D-RE-306029-MP-HC-R	30	60	29	121	1755
	Panel,	E2-D-RE-306629-MP-HC-R	30	66	29	131	1809
	Return Right	E2-D-RE-307229-MP-HC-R	30	72	29	140	1862
Radius End desk has modesty panel and half cylinder. Connecting top to the RIGHT of user.							

EQUATIONS² - Component Pricing

Description	Model	Dimensions			Wgt	List Prices WoodPlus ²
		Deep	Long	High		
E2 Angled Radius End Desk, WoodPlus2						
Angled Radius	E2-D-ARE-307629-C4-L	30	76	29	185	2118
End Desk	E2-D-ARE-307629-C4-R	30	76	29	185	2118

Allows use of 24" return top, or may be freestanding.

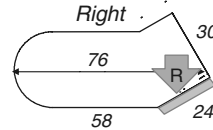
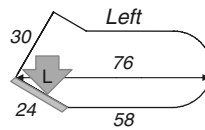
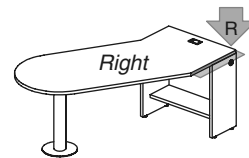
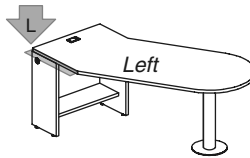
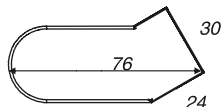
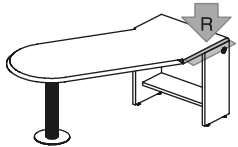
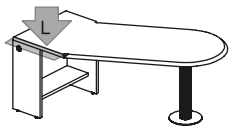

E2 Keyhole desk

Column,	E2-D-KH-366029-BBF-C4-L	36	60	29	141	1796
Pedestal	E2-D-KH-366629-BBF-C4-L	36	66	29	147	1906
Left	E2-D-KH-367229-BBF-C4-L	36	72	29	153	1959

Keyhole desk has Box Box File pedestal with lock.
Pedestal is to the LEFT of the user. Specify Pull.

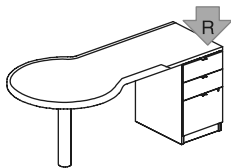
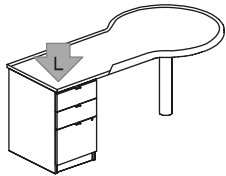

Column,	E2-D-KH-366029-BBF-C4-R	36	60	29	141	1796
Pedestal	E2-D-KH-366629-BBF-C4-R	36	66	29	147	1906
Right	E2-D-KH-367229-BBF-C4-R	36	72	29	153	1959

Keyhole desk has Box Box File pedestal with lock.
Pedestal is to the RIGHT of the user. Specify Pull.

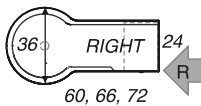

Option	OPTION-TAPERED-LEG					74
--------	--------------------	--	--	--	--	----

To order the Tapered Leg in place of the 4 inch column add ' -TL' to the model number.

E2 Keyhole top desk, no pedestal, for L or U configuration

Column,	E2-D-KH-366029-C4-L	36	60	29	83	1144
Return Left	E2-D-KH-366629-C4-L	36	66	29	89	1254
	E2-D-KH-367229-C4-L	36	72	29	95	1307

Keyhole desk. Connecting top is to the LEFT of the user.

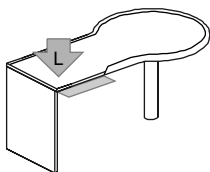

EQ2-603-L-KH...

Column,	E2-D-KH-366029-C4-R	36	60	29	83	1144
Return Right	E2-D-KH-366629-C4-R	36	66	29	89	1254
	E2-D-KH-367229-C4-R	36	72	29	95	1307

Keyhole desk. Connecting top is to the RIGHT of the user.

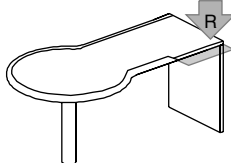

EQ2-603-R-KH...

Option	OPTION-COLUMN-BASE-PLATE	12	12		8	68
	OPTION-TAPERED-LEG					74
	OPTION-GRE					48

This 12" diameter plate attaches to the bottom of the 4" column (not to the Tapered Leg).
Required when the EQ2-603- model is freestanding (i.e. no bridge or return is connected to it).
To order add ' -CBP' after the model number.

To order the Tapered Leg in place of the 4 inch column add ' -TL' to the model number.

With the Tapered Leg, the desk must be attached to return or bridge top.

To order a worktop grommet at the ' flat' end of the desk add ' -GRE' to the model number .

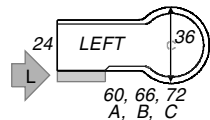

60, 66, 72
A, B, C

EQUATIONS² - Component Pricing

Description	Model	Dimensions			Wgt	List Prices WoodPlus ²
		Deep	Long	High		



E2 P desk

P Top Desks

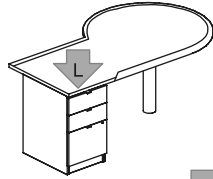

Column,	E2-D-P-426629-BBF-C4-L	42	66	29	177	2139
Pedestal	E2-D-P-427229-BBF-C4-L	42	72	29	185	2193

Left
P top desk has column support and Box Box File pedestal with lock.
Pedestal is to the LEFT of the user. Specify Pull.

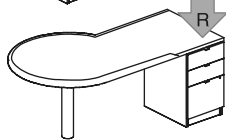

Column,	E2-D-P-426629-BBF-C4-R	42	66	29	177	2139
Pedestal	E2-D-P-427229-BBF-C4-R	42	72	29	185	2193

Right
P top desk has column support and Box Box File pedestal with lock. Specify Pull.
Pedestal is to the RIGHT of the user.

Option	OPTION-TAPERED-LEG					74
---------------	---------------------------	--	--	--	--	-----------

To order the Tapered Leg in place of the 4 inch column add '-TL' to the model number.

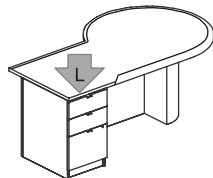

Modesty Panel,	E2-D-P-426629-BBF-MP-HC-L	42	66	29	203	2849
Pedestal	E2-D-P-427229-BBF-MP-HC-L	42	72	29	215	2903

Left
P top desk has modesty panel, half cylinder and Box Box File pedestal with lock.
Pedestal is to the LEFT of the user. Specify Pull.

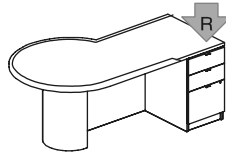

Modesty Panel,	E2-D-P-426629-BBF-MP-HC-R	42	66	29	203	2849
Pedestal	E2-D-P-427229-BBF-MP-HC-R	42	72	29	215	2903

Right
P top desk has modesty panel, half cylinder and Box Box File pedestal with lock.
Pedestal is to the RIGHT of the user. Specify Pull.

E2 P top desk, no pedestal, for L or U configuration

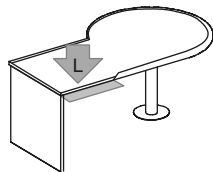

P top	E2-D-P-426629-C4-L	42	66	29	125	1498
Return	E2-D-P-427229-C4-L	42	72	29	133	1552

Left
P top desk has column support.
Connecting top is to the LEFT of the user.

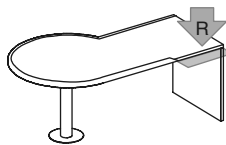

P top	E2-D-P-426629-C4-R	42	66	29	125	1498
Return	E2-D-P-427229-C4-R	42	72	29	133	1552

Right
P top desk has column support.
Connecting top is to the RIGHT of the user.

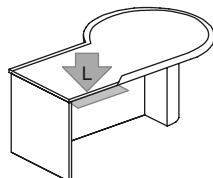

P top	E2-D-P-426629-MP-HC-L	42	66	29	151	2208
Return	E2-D-P-427229-MP-HC-L	42	72	29	163	2262

Left
P top desk has modesty panel and half cylinder.
Connecting top is to the LEFT of the user.

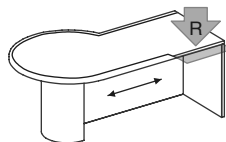

P top	E2-D-P-426629-MP-HC-R	42	66	29	151	2208
Return	E2-D-P-427229-MP-HC-R	42	72	29	163	2262

Right
P top desk has modesty panel and half cylinder.
Connecting top is to the RIGHT of the user.

Option	OPTION-TAPERED-LEG					74
---------------	---------------------------	--	--	--	--	-----------

OPTION-GRE

48

To order the Tapered Leg in place of the 4 inch column add '-TL' to the model number.

To order a worktop grommet at the 'flat' end of the desk add '-GRE' to the model number.

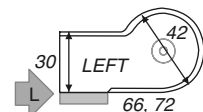

EQUATIONS² - Component Pricing

Description	Model	Dimensions			Wgt	List Prices WoodPlus ²
		Deep	Long	High		



E2 Shark desk

Shark Desks

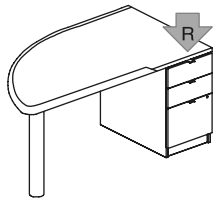
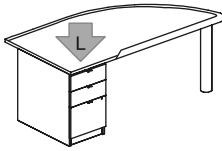

Pedestal	E2-D-SH-366029-BBF-C4-L	36	60	29	141	1796
Left	E2-D-SH-366629-BBF-C4-L	36	66	29	147	1906
	E2-D-SH-367229-BBF-C4-L	36	72	29	153	1959

Shark desk has Box Box File pedestal with lock.
Pedestal is to the LEFT of the user. Specify Pull.

Pedestal	E2-D-SH-366029-BBF-C4-R	36	60	29	141	1796
Right	E2-D-SH-366629-BBF-C4-R	36	66	29	147	1906
	E2-D-SH-367229-BBF-C4-R	36	72	29	153	1959

Shark desk has Box Box File pedestal with lock.
Pedestal is to the RIGHT of the user. Specify Pull.

Option	OPTION-TAPERED-LEG					74
---------------	---------------------------	--	--	--	--	-----------

To order the Tapered Leg in place of the 4 inch column add '-TL' to the model number.

E2 Shark desk, no pedestal, for L or U configuration

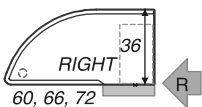
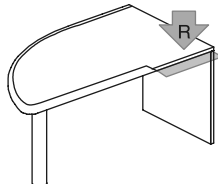
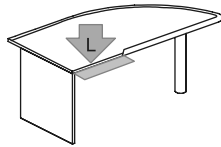

Return	E2-D-SH-366029-C4-L	36	60	29	89	1155
Left	E2-D-SH-366629-C4-L	36	66	29	95	1265
	E2-D-SH-367229-C4-L	36	72	29	101	1318

Shark desk.
Connecting top is to the LEFT of the user.

Return	E2-D-SH-366029-C4-R	36	60	29	89	1155
Right	E2-D-SH-366629-C4-R	36	66	29	95	1265
	E2-D-SH-367229-C4-R	36	72	29	101	1318

Shark desk.
Connecting top is to the RIGHT of the user.



Option	OPTION-COLUMN-BASE-PLATE	12	12		8	68
	OPTION-TAPERED-LEG					74
	OPTION-GRE					48

This 12" diameter plate attaches to the bottom of the 4" column (not to the Tapered Leg).
Required when the EQ2-608- model is freestanding (i.e. no bridge or return is connected to it).
To order, add '-CBP' after the model number.

To order the Tapered Leg in place of the 4 inch column add '-TL' to the model number.
With the Tapered Leg, the desk must be attached to return or bridge top.

To order a worktop grommet at the 'flat' end of the desk, add '-GRE' to the model number.

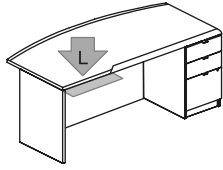
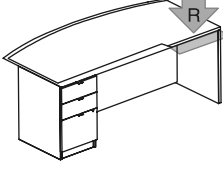
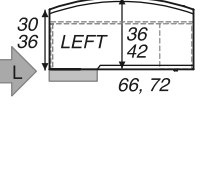
EQUATIONS² - Component Pricing

Description	Model	Dimensions			Wgt	List Prices WoodPlus ²	
		Deep	Long	High			
E2 Bow front desk							
<i>Bow Front Desks</i> 	36 deep,	E2-D-BO-366629-BBF-MP-L	36	66	29	210	2151
	Return	E2-D-BO-367229-BBF-MP-L	36	72	29	219	2206
Left	Bow front desk with modesty panel. 24 deep Box Box File pedestal with lock. Specify Pull. Connecting top is to the LEFT of the user.						
	36 deep,	E2-D-BO-366629-BBF-MP-R	36	66	29	210	2151
	Return	E2-D-BO-367229-BBF-MP-R	36	72	29	219	2206
Right	Bow front desk with modesty panel. 24 deep Box Box File pedestal with lock. Specify Pull. Connecting top is to the RIGHT of the user.						
	42 deep,	E2-D-BO-426629-BBF-MP-L	42	66	29	246	2325
	Return	E2-D-BO-427229-BBF-MP-L	42	72	29	257	2379
Left	Bow front desk with modesty panel. 30 deep Box Box File pedestal with lock. Specify Pull. Connecting top is to the LEFT of the user.						
	42 deep,	E2-D-BO-426629-BBF-MP-R	42	66	29	246	2325
	Return	E2-D-BO-427229-BBF-MP-R	42	72	29	257	2379
Right	Bow front desk with modesty panel. 30 deep Box Box File pedestal with lock. Specify Pull. Connecting top is to the RIGHT of the user.						
Option	To order a worktop grommet to the LEFT of the user, add ' -GREL' to the model number. To order a worktop grommet to the RIGHT of the user, add ' -GRER' to the model number.						

E2 Bow front desk, two pedestals

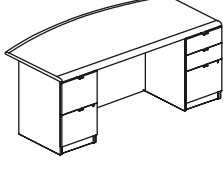
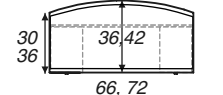
<i>Bow Front Desks</i> 	36 deep	E2-D-BO-366629-FF-MP-BBF	36	66	29	268	2803
		E2-D-BO-367229-FF-MP-BBF	36	72	29	277	2858
Bow front desk with modesty panel. 24 deep Box Box File pedestal with lock and 24 deep File File pedestal with lock. Specify Pulls.							
	42 deep	E2-D-BO-426629-FF-MP-BBF	42	66	29	298	2966
		E2-D-BO-427229-FF-MP-BBF	42	72	29	309	3020
Bow front desk with modesty panel. 30 deep Box Box File pedestal with lock and 30 deep File File pedestal with lock. Specify Pulls.							

EQUATIONS² - Component Pricing

Description	Model	Dimensions			Wgt	List Prices WoodPlus ²
		Deep	Long	High		



E2 Rectangular desk

Rectangular Desks
with Modesty Panel

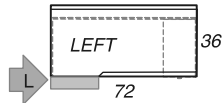
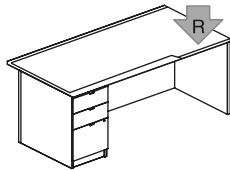
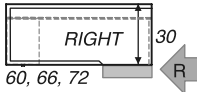
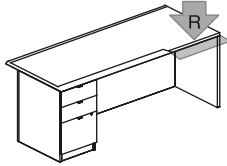

30 deep,	E2-D-TT-306029-BBF-MP-L	30	60	29	200	1934
Return	E2-D-TT-306629-BBF-MP-L	30	66	29	210	1990
Left	E2-D-TT-307229-BBF-MP-L	30	72	29	219	2044

Rectangular desk with modesty panel. 24 deep Box Box file pedestal with lock. Specify Pull. Connection top is to the LEFT of the user.

30 deep,	E2-D-TT-306029-BBF-MP-R	30	60	29	200	1934
Return	E2-D-TT-306629-BBF-MP-R	30	66	29	210	1990
Right	E2-D-TT-307229-BBF-MP-R	30	72	29	219	2044

Rectangular desk with modesty panel. 24 deep Box Box file pedestal with lock. Specify Pull. Connection top is to the RIGHT of the user.

36 deep,	E2-D-TT-367229-BBF-MP-L	36	72	29	240	2217
Return						
Left						

Rectangular desk with modesty panel. 30 deep Box Box file pedestal with lock. Specify Pull. Connection top is to the LEFT of the user.

36 deep,	E2-D-TT-367229-BBF-MP-R	36	72	29	240	2217
Return						
Right						

Rectangular desk with modesty panel. 30 deep Box Box file pedestal with lock. Specify Pull. Connection top is to the RIGHT of the user.

Option To order a worktop grommet to the LEFT of the user, add ' -GREL' to the model number .
To order a worktop grommet to the RIGHT of the user, add ' -GRER' to the model number .

E2 Rectangular desk, two pedestals

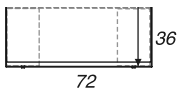
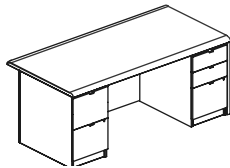

30 deep desk	E2-D-TT-306029-FF-MP-BBF	30	60	29	258	2586
Double	E2-D-TT-306629-FF-MP-BBF	30	66	29	268	2642
pedestal	E2-D-TT-307229-FF-MP-BBF	30	72	29	277	2696

Rectangular desk with modesty panel.
24 deep Box Box file pedestal with lock and 24 deep File File pedestal with lock. Specify Pull.

36 deep desk	E2-D-TT-367229-FF-MP-BBF	36	72	29	292	2858
Double						
pedestal						

Rectangular desk with modesty panel.
30 deep Box Box file pedestal with lock and 30 deep File File pedestal with lock. Specify Pull.

EQUATIONS² - Component Pricing

Description	Model	Dimensions			Wgt	List Prices WoodPlus ²
		Deep	Long	High		



E2 Corner

Corner Component

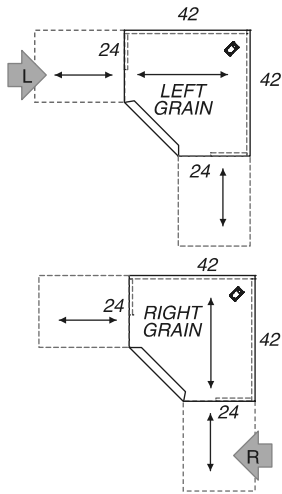

Grain Left	E2-CNR-424229-24-L	42	42	29	126	1484
-------------------	---------------------------	----	----	----	-----	-------------

Uses 24" deep return.

Two AB-8 8" long angle brackets are included. These are used with the SPLICE-PLATE-OVAL brackets included with the return and bridge components to attach returns or bridges to this corner component.

GRC Grommet is included.

Grain Right	E2-CNR-424229-24-R	42	42	29	126	1484
--------------------	---------------------------	----	----	----	-----	-------------

Uses 24" deep return.

Two AB-8 8" long angle brackets are included. These are used with the SPLICE-PLATE-OVAL brackets included with the return and bridge components to attach returns or bridges to this corner component.

GRC Grommet is included.

E2 Return

Returns with End Panel

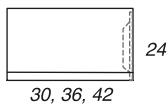
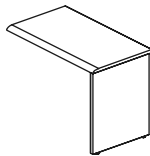

Return	E2-R-TT-243029	24	30	29	50	492
	E2-R-TT-243629	24	36	29	55	547
	E2-R-TT-244229	24	42	29	59	599

Hutch placed on a return requires pedestal or cabinet below the hutch end panel.

Do not use this type of return to support hutch end.

Options	OPTION-MP-RETURN	168
	OPTION-GRC	48

48

EQUATIONS² - Component Pricing

Description

Model

Dimensions
Deep Long High

Wgt

List Prices
WoodPlus²

E2 Return with pedestal

Returns with Pedestal

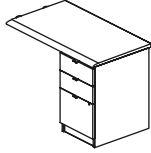

Description	Model	Deep	Long	High	Wgt	List Prices
Box Box File pedestal	E2-R-TT-243029-BBF	24	30	29	108	1144
	E2-R-TT-243629-BBF	24	36	29	113	1199
	E2-R-TT-244229-BBF	24	42	29	117	1251
	E2-R-TT-244829-BBF	24	48	29	122	1307
	E2-R-TT-245429-BBF	24	54	29	127	1361
	E2-R-TT-246029-BBF	24	60	29	136	1488

Box Box File pedestal with lock. Specify Pull.
GRC grommet available on 36 long to 60 long.
GRC grommet NOT available on 30 long.

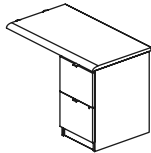

Description	Model	Deep	Long	High	Wgt	List Prices
File File pedestal	E2-R-TT-243029-FF	24	30	29	108	1144
	E2-R-TT-243629-FF	24	36	29	113	1199
	E2-R-TT-244229-FF	24	42	29	117	1251
	E2-R-TT-244829-FF	24	48	29	122	1307
	E2-R-TT-245429-FF	24	54	29	127	1361
	E2-R-TT-246029-FF	24	60	29	136	1488

File File pedestal with lock. Specify Pull.
GRC grommet available on 36 long to 60 long.
GRC grommet NOT available on 30 long.



Options	OPTION-GRC	48
	OPTION-MP-RETURN	168

GRC grommet in center of top at back is available on 36 long through 60 long.

Returns include hardware to connect to desk, credenza or corner unit.
Pedestal may be either to the left or right of the top.

E2 Return Lateral File 30 wide

Returns with Cabinets

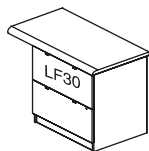

Lateral File	E2-R-TT-244229-LF30	24	42	29	173	1629
--------------	---------------------	----	----	----	-----	------

30 wide two drawer lateral file drawer cabinet with lock. Specify Pull.

Options	OPTION-MP-RETURN	168
---------	------------------	-----

Returns include hardware to connect to desk, credenza or corner unit.
Cabinet may be placed either to the left or right.

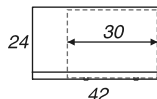

EQUATIONS² - Component Pricing

Description	Model	Dimensions			Wgt	List Prices WoodPlus ²
		Deep	Long	High		

E2 Return with Combo cabinet or Lateral File

Returns with Cabinets

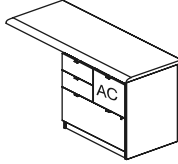

Combo A	E2-R-TT-244829-AC	24	48	29	178	1685
	E2-R-TT-245429-AC	24	54	29	183	1739
	E2-R-TT-246029-AC	24	60	29	188	1792

Lateral File drawer and File drawer locked.
Two Box drawers not locked. Specify Pull.

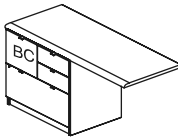

Combo B	E2-R-TT-244829-BC	24	48	29	178	1685
	E2-R-TT-245429-BC	24	54	29	183	1739
	E2-R-TT-246029-BC	24	60	29	188	1792

Lateral File drawer and File drawer locked.
Two Box drawers not locked. Specify Pull.

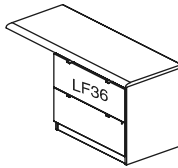

Lateral File	E2-R-TT-244829-LF	24	48	29	178	1685
	E2-R-TT-245429-LF	24	54	29	183	1739
	E2-R-TT-246029-LF	24	60	29	188	1792

Two lateral file drawers with lock. Specify Pull.

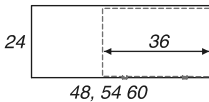

Options	OPTION-MP-RETURN					168
----------------	-------------------------	--	--	--	--	------------

Returns include hardware to connect to desk, credenza or corner unit.
Cabinet may be either to the left or right of the top.

E2 Bridge

Bridge Tops

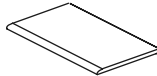

Bridge	E2-B-TT-243029	24	30	29	28	303
	E2-B-TT-243629	24	36	29	33	358
	E2-B-TT-244229	24	42	29	37	410
	E2-B-TT-244829	24	48	29	45	537
	E2-B-TT-245429	24	54	29	51	594

The 48 and 54 long bridge tops includes a top support rail.

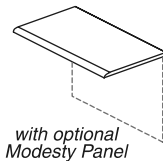



with optional
Modesty Panel

Options	OPTION-MP-BRIDGE					168
	OPTION-GRC					48

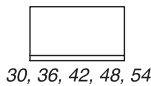
Bridge includes hardware to connect to each end to desk, credenza or corner unit.

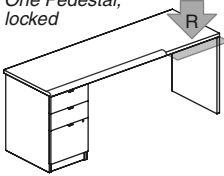
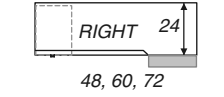
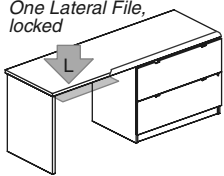
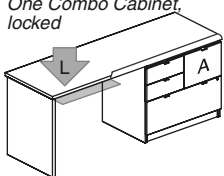
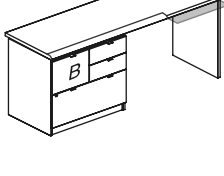
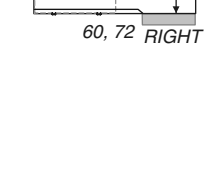

EQUATIONS² - Component Pricing

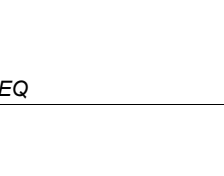
Description	Model	Dimensions			Wgt	List Prices WoodPlus ²	
		Deep	Long	High			
E2 Credenza U							
24" Deep Credenzas One Pedestal, locked 	Box Box File,	E2-CR-TT-244829-BBF-L	24	48	29	144	1496
	Return	E2-CR-TT-246029-BBF-L	24	60	29	158	1677
	Left	E2-CR-TT-247229-BBF-L	24	72	29	168	1794
Box Box File pedestal with lock. Specify Pull. Connecting top is to the LEFT of the credenza.							
	Box Box File,	E2-CR-TT-244829-BBF-R	24	48	29	144	1496
	Return	E2-CR-TT-246029-BBF-R	24	60	29	158	1677
	Right	E2-CR-TT-247229-BBF-R	24	72	29	168	1794
Box Box File pedestal with lock. Specify Pull. Connecting top is to the RIGHT of the credenza.							
One Lateral File, locked 	Lateral File,	E2-CR-TT-246029-LF-L	24	60	29	210	1981
	Return	E2-CR-TT-247229-LF-L	24	72	29	219	2089
	Left	One each 36 wide two drawer lateral file cabinet with lock. Specify Pull. Connecting top is to the LEFT of the credenza.					
	Lateral File,	E2-CR-TT-246029-LF-R	24	60	29	210	1981
	Return	E2-CR-TT-247229-LF-R	24	72	29	219	2089
	Right	One each 36 wide two drawer lateral file cabinet with lock. Specify Pull. Connecting top is to the RIGHT of the credenza.					
One Combo Cabinet, locked 	Combo-A,	E2-CR-TT-246029-AC-L	24	60	29	210	1981
	Return	E2-CR-TT-247229-AC-L	24	72	29	219	2089
	Left	One each Combo-A cabinet with one LF drawer and one File drawer, both are locked. Two Box drawers are not locked. Specify Pulls. Connecting top is to the LEFT of the credenza.					
	Combo-A,	E2-CR-TT-246029-AC-R	24	60	29	210	1981
	Return	E2-CR-TT-247229-AC-R	24	72	29	219	2089
	Right	One each Combo-A cabinet with one LF drawer and one File drawer, both are locked. Two Box drawers are not locked. Specify Pulls. Connecting top is to the RIGHT of the credenza.					
	Combo-B,	E2-CR-TT-246029-BC-L	24	60	29	210	1981
	Return	E2-CR-TT-247229-BC-L	24	72	29	219	2089
	Left	One each Combo-B cabinet with one LF drawer and one File drawer, both are locked. Two Box drawers are not locked. Specify Pulls. Connecting top is to the LEFT of the credenza.					
	Combo-B,	E2-CR-TT-246029-BC-R	24	60	29	210	1981
	Return	E2-CR-TT-247229-BC-R	24	72	29	219	2089
	Right	One each Combo-B cabinet with one LF drawer and one File drawer, both are locked. Two Box drawers are not locked. Specify Pulls. Connecting top is to the RIGHT of the credenza.					
Options		OPTION-GREL or GRER					48
		OPTION-MP-CRENDENZA					168
To order a worktop grommet to the LEFT of the user, add ' -GREL' to the model number . To order a worktop grommet to the RIGHT of the user, add ' -GRER' to the model number .							
To order a Modesty Panel, add ' -MP' to the model number.							

EQUATIONS² - Component Pricing

Description	Model	Dimensions			Wgt	List Prices WoodPlus ²
		Deep	Long	High		

E2 Credenza double pedestals

24" Deep Credenzas

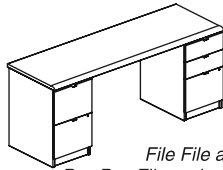

File File and
Box Box File pedestal,
both locked

BBF and FF	E2-CR-TT-246029-FF-BBF	24	60	29	212	2255
	E2-CR-TT-247229-FF-BBF	24	72	29	221	2363

Box Box File pedestal with lock. Specify Pull.

File File pedestal with lock. Specify Pull.

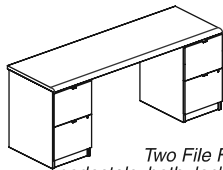

Two File File
pedestals, both locked

Two each FF	E2-CR-TT-246029-FF-FF	24	60	29	212	2255
	E2-CR-TT-247229-FF-FF	24	72	29	221	2363

Two each File File pedestal with lock. Specify Pull.

Options	OPTION-MP-CREDENZA					168
	OPTION-GRC					48

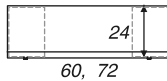

E2 Credenza door storage

Filled Credenzas
24" deep

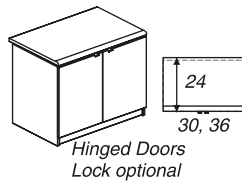

Hinged Doors
Lock optional

Door Storage	E2-CR-TT-243029-DS	24	30	29	149	1110
24 deep	E2-CR-TT-243629-DS	24	36	29	167	1165

LOCK-ONE-PR-HINGED-DOORS

87

One door storage cabinet with one pair of hinged doors. Specify Pull.

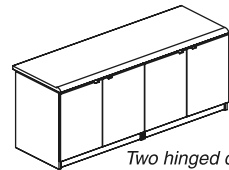

Two hinged door
cabinets, Locks optional

	E2-CR-TT-246029-DS-DS	24	60	29	298	2219
	E2-CR-TT-247229-DS-DS	24	72	29	333	2327

LOCK-TWO-PR-HINGED-DOORS

174

Two each door storage cabinets with one pair of doors per cabinet. Specify Pull.

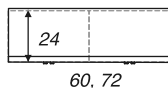

EQUATIONS² - Component Pricing

Description	Model	Dimensions			Wgt	List Prices WoodPlus ²
		Deep	Long	High		

E2 Credenza filled with pedestals, door storage

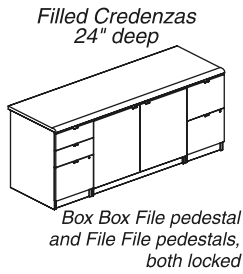

BBF and FF,	E2-CR-TT-246029-BBF-DS-FF	24	60	29	337	3001
Door storage	E2-CR-TT-247229-BBF-DS-FF	24	72	29	359	3202

Box Box File pedestal with lock. Specify Pull.
File File pedestal with lock. Specify Pull.
Door storage between pedestals.

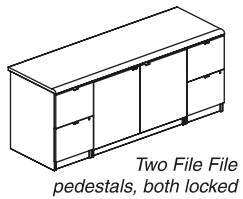

2 File File	E2-CR-TT-246029-FF-DS-FF	24	60	29	337	3001
Door storage	E2-CR-TT-247229-FF-DS-FF	24	72	29	359	3202

Two each File File pedestals with lock. Specify Pull.
Door storage between pedestals. Specify Pull.

Lock Hinged Doors	Lock for one pair of doors between pedestals.					87
------------------------------	---	--	--	--	--	-----------

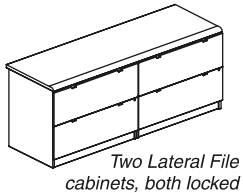
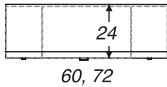

Two Lateral Files	E2-CR-TT-246029-LF-LF	24	60	29	324	3011
	E2-CR-TT-247229-LF-LF	24	72	29	333	3119

Two each two drawer lateral file cabinets with locks. Specify Pull.

Options	OPTION-MP-CRE DENZA					168
----------------	----------------------------	--	--	--	--	------------

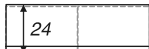

EQUATIONS² - Component Pricing

Description	Model	Dimensions			Wgt	List Prices WoodPlus ²
		Deep	Long	High		



E2 Hutches standard height -35 - matches the height of 65" high storage tower

Equations² Hutches

Hinged Doors

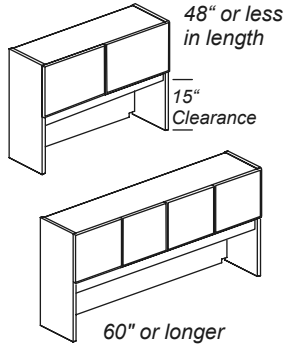

Hinged doors

E2-H-TI-153035-HD	15	30	35	86	1047
E2-H-TI-153635-HD	15	36	35	93	1061
E2-H-TI-154235-HD	15	42	35	98	1173
E2-H-TI-154835-HD	15	48	35	112	1173

OPTIONAL LOCK FOR ONE PAIR OF HINGED DOORS

87

Add ' -LOCK' to the model number to add locks to hinged doors. Specify Pull.

E2-H-TI-156035-HD	15	60	35	147	1489
E2-H-TI-156635-HD	15	66	35	164	1539
E2-H-TI-157235-HD	15	72	35	181	1555
E2-H-TI-157835-HD	15	78	35	173	1639
E2-H-TI-158435-HD	15	84	35	182	1639
E2-H-TI-159035-HD	15	90	35	192	2097
E2-H-TI-159635-HD	15	96	35	202	2097

OPTIONAL LOCK FOR TWO PAIRS OF HINGED DOORS

174

Add ' -LOCK' to the model number to add locks to hinged doors. Specify Pull.

Shaped Doors

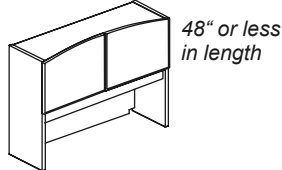

Shaped hinged doors

E2-H-TI-153035-SD	15	30	35	88	1118
E2-H-TI-153635-SD	15	36	35	95	1132
E2-H-TI-154235-SD	15	42	35	104	1244
E2-H-TI-154835-SD	15	48	35	112	1244

Applied pulls and locks not available with shaped doors.

Center pair of Shaped Doors

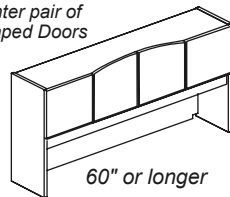

E2-H-TI-156035-SD	15	60	35	147	1560
E2-H-TI-156635-SD	15	66	35	164	1610
E2-H-TI-157235-SD	15	72	35	181	1626
E2-H-TI-157835-SD	15	78	35	173	1710
E2-H-TI-158435-SD	15	84	35	182	1710
E2-H-TI-159035-SD	15	90	35	192	2168
E2-H-TI-159635-SD	15	96	35	202	2168

Applied pulls and locks not available with shaped doors.

Glass Doors, WoodPlus² Frames

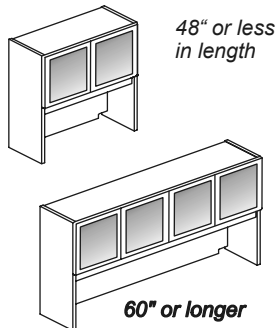

Glass doors, WoodPlus² frame

E2-H-TI-153035-GW	15	30	35	86	1363
E2-H-TI-153635-GW	15	36	35	93	1378
E2-H-TI-154235-GW	15	42	35	98	1490
E2-H-TI-154835-GW	15	48	35	112	1490

Applied pulls and locks not available on Glass Doors.

E2-H-TI-156035-GW	15	60	35	147	2118
E2-H-TI-156635-GW	15	66	35	164	2168
E2-H-TI-157235-GW	15	72	35	181	2183
E2-H-TI-157835-GW	15	78	35	173	2327
E2-H-TI-158435-GW	15	84	35	182	2387
E2-H-TI-159035-GW	15	90	35	192	3015
E2-H-TI-159635-GW	15	96	35	202	3154

Applied pulls and locks not available on Glass Doors.

GW = Glass doors with WoodPlus² frame

GW doors use frosted glass. For clear glass, please add List \$210 per unit.

All Equations² Hutch doors fully overlay the hutch case.

EQUATIONS² - Component Pricing

Description	Model	Dimensions			Wgt	List Prices WoodPlus ²
		Deep	Long	High		



E2 Hutches extended height -42 - matches the height of 72" high storage tower

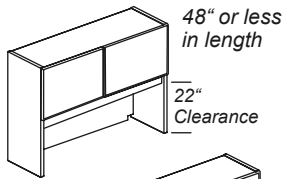

Hinged doors

E2-H-TI-153042-HD	15	30	42	86	1128
E2-H-TI-153642-HD	15	36	42	93	1153
E2-H-TI-154242-HD	15	42	42	98	1281
E2-H-TI-154842-HD	15	48	42	112	1281
OPTIONAL LOCK FOR ONE PAIR OF HINGED DOORS					87

Add ' -LOCK ' to the model number to add locks to hinged doors. Specify Pull.

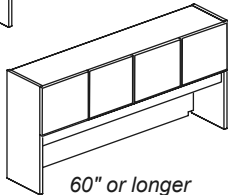

E2-H-TI-156042-HD	15	60	42	142	1610
E2-H-TI-156642-HD	15	66	42	157	1669
E2-H-TI-157242-HD	15	72	42	172	1694
E2-H-TI-157842-HD	15	78	42	195	1788
E2-H-TI-158442-HD	15	84	42	205	1788
E2-H-TI-159042-HD	15	90	42	216	2246
E2-H-TI-159642-HD	15	96	42	228	2246
OPTIONAL LOCK FOR TWO PAIRS OF HINGED DOORS					174

Add ' -LOCK ' to the model number to add locks to hinged doors. Specify Pull.

Shaped Doors

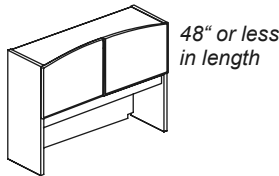

Shaped hinged doors

E2-H-TI-153042-SD	15	30	42	88	1199
E2-H-TI-153642-SD	15	36	42	95	1224
E2-H-TI-154242-SD	15	42	42	104	1352
E2-H-TI-154842-SD	15	48	42	112	1352

Applied pulls and locks not available with shaped doors.

Center pair of Shaped Doors

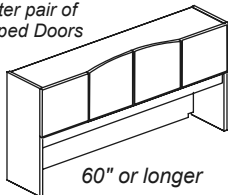

E2-H-TI-156042-SD	15	60	42	142	1682
E2-H-TI-156642-SD	15	66	42	157	1741
E2-H-TI-157242-SD	15	72	42	172	1765
E2-H-TI-157842-SD	15	78	42	195	1859
E2-H-TI-158442-SD	15	84	42	205	1859
E2-H-TI-159042-SD	15	90	42	216	2317
E2-H-TI-159642-SD	15	96	42	228	2317

Applied pulls and locks not available with shaped doors.

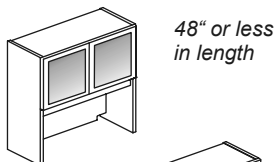

Glass doors, WoodPlus2 frame

E2-H-TI-153042-GW	15	30	42	86	1445
E2-H-TI-153642-GW	15	36	42	93	1470
E2-H-TI-154242-GW	15	42	42	98	1597
E2-H-TI-154842-GW	15	48	42	112	1597

Applied pulls and locks not available on Glass Doors.

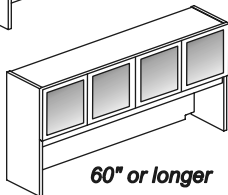

E2-H-TI-156042-GW	15	60	42	142	2240
E2-H-TI-156642-GW	15	66	42	157	2299
E2-H-TI-157242-GW	15	72	42	172	2323
E2-H-TI-157842-GW	15	78	42	195	2503
E2-H-TI-158442-GW	15	84	42	205	2563
E2-H-TI-159042-GW	15	90	42	216	3191
E2-H-TI-159642-GW	15	96	42	228	3331



Applied pulls and locks not available on Glass Doors.

GW = Glass doors with WoodPlus2 frame

GW doors use frosted glass. For clear glass, please add List \$210 per unit.

All Equations² Hutch doors fully overlay the hutch case.

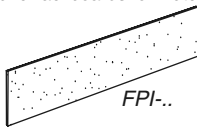
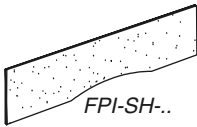
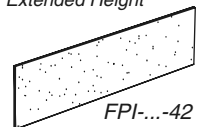
EQUATIONS² - Component Pricing

Description	Model	Dimensions			Wgt	List Prices WoodPlus ²		
		Deep	Long	High				
Hutch fabric panels FPI								
Note: All fabrics are now installed on tackboards with the 'direction' (the length of the fabric as it is pulled off the roll) vertical.								
 <p>Fabric Tackboards for Hutches</p>	Tackboards for 35" high hutch	FPI-30L-35H	0.5	27	17.5	3	222	
		FPI-36L-35H	0.5	33	17.5	5	222	
		FPI-42L-35H	0.5	39	17.5	6	222	
		FPI-48L-35H	0.5	45	17.5	7	222	
		FPI-60L-35H	0.5	57	17.5	9	222	
		FPI-66L-35H	0.5	63	17.5	10	254	
	Two piece construction at 72" or longer	FPI-72L-35H	0.5	69	17.5	11	254	
		FPI-78L-35H	0.5	75	17.5	12	286	
		FPI-84L-35H	0.5	81	17.5	13	286	
		FPI-90L-35H	0.5	87	17.5	14	286	
		FPI-96L-35H	0.5	93	17.5	14	286	
	 <p>FPI-SH...</p>	Shaped tackboards for 35" high hutch	FPI-SH-30L-35H	0.5	27	17.5	3	222
			FPI-SH-36L-35H	0.5	33	17.5	5	222
		FPI-SH-42L-35H	0.5	39	17.5	6	222	
		FPI-SH-48L-35H	0.5	45	17.5	7	222	
		FPI-SH-60L-35H	0.5	57	17.5	9	222	
		FPI-SH-66L-35H	0.5	63	17.5	10	254	
Two piece construction at 72" or longer		FPI-SH-72L-35H	0.5	69	17.5	11	254	
		FPI-SH-78L-35H	0.5	75	17.5	12	286	
		FPI-SH-84L-35H	0.5	81	17.5	13	286	
		FPI-SH-90L-35H	0.5	87	17.5	14	286	
		FPI-SH-96L-35H	0.5	93	17.5	14	286	
 <p>For Extended Height</p> <p>FPI-...-42</p>		Tackboards for 42" high hutch	FPI-30L-42H	0.5	27	24.5	4	222
			FPI-36L-42H	0.5	33	24.5	6	222
		FPI-42L-42H	0.5	39	24.5	8	222	
		FPI-48L-42H	0.5	45	24.5	9	222	
		FPI-60L-42H	0.5	57	24.5	10	222	
		FPI-66L-42H	0.5	63	24.5	11	254	
	Two piece construction at 72" or longer	FPI-72L-42H	0.5	69	24.5	12	254	
		FPI-78L-42H	0.5	75	24.5	12	286	
		FPI-84L-42H	0.5	81	24.5	13	286	
		FPI-90L-42H	0.5	87	24.5	14	286	
		FPI-96L-42H	0.5	93	24.5	14	286	
	 <p>FPI-SH...-42</p>	Shaped tackboards for 42" high hutch	FPI-SH-30L-42H	0.5	27	24.5	4	222
			FPI-SH-36L-42H	0.5	33	24.5	6	222
		FPI-SH-42L-42H	0.5	39	24.5	8	222	
		FPI-SH-48L-42H	0.5	45	24.5	9	222	
		FPI-SH-60L-42H	0.5	57	24.5	10	222	
		FPI-SH-66L-42H	0.5	63	24.5	11	254	
Two piece construction at 72" or longer		FPI-SH-72L-42H	0.5	69	24.5	12	254	
		FPI-SH-78L-42H	0.5	75	24.5	12	286	
		FPI-SH-84L-42H	0.5	81	24.5	13	286	
		FPI-SH-90L-42H	0.5	87	24.5	14	286	
		FPI-SH-96L-42H	0.5	93	24.5	14	286	

Most standard Guilford Panel Fabrics are available on MagnaFLEX lead time.

If the fabric is not listed in our specifications, please contact factory for Fabric Grade, availability, lead time and pricing.

Pricing shown is for Magna designated Fabric Grades A, B, C.

For COM fabric, please use the pricing shown above.

A sample of the COM fabric plus the fabric specifications such as width of roll, directional or non-directional is required.

EQUATIONS² - Component Pricing

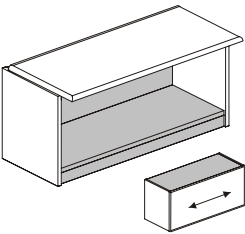
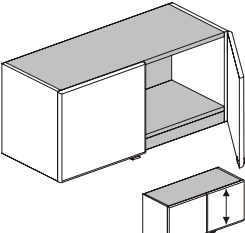
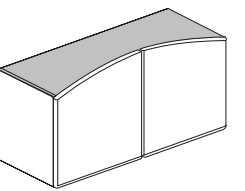
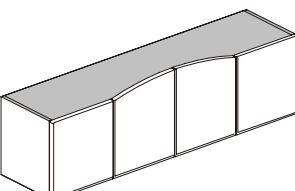
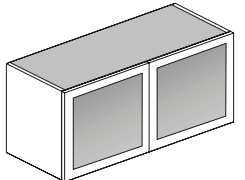
Description	Model	Dimensions			Wgt	List Prices WoodPlus ²	
		Deep	Long	High			
E2 Overheads							
 <p>Flipper Door Wall Mount, 30" to 60" wide</p>	One flipper door	E2-OW-153016-FDT	14.75	30	16	46	727
		E2-OW-153616-FDT	14.75	36	16	53	799
		E2-OW-154216-FDT	14.75	42	16	60	864
		E2-OW-154816-FDT	14.75	48	16	67	914
		OPTION-LOCK-FLIPPER-DOOR					87
Add '-LOCK' to model number to lock doors.							
	Two flipper doors	E2-OW-155416-FDT	14.75	54	16	74	1137
		E2-OW-156016-FDT	14.75	60	16	81	1174
		OPTION-LOCK-FLIPPER-DOORS					174
	Add '-LOCK' to model number to lock doors						
 <p>Hinged Door Wall Mount, 30" to 60" wide</p>	One pair hinged doors	E2-OW-153016-HDT	14.75	30	16	46	727
		E2-OW-153616-HDT	14.75	36	16	53	799
		E2-OW-154216-HDT	14.75	42	16	60	864
		E2-OW-154816-HDT	14.75	48	16	67	914
		LOCK-ONE-PAIR-DOORS					87
Add '-LOCK' to model number to lock doors. Specify Pull.							
	Two pair hinged doors	E2-OW-155416-HDT	14.75	54	16	74	1137
		E2-OW-156016-HDT	14.75	60	16	81	1174
		LOCK-TWO-PAIR-DOORS					174
	Add '-LOCK' to model number to lock doors. Specify Pull.						
 <p>Shaped hinged door Wall Mount, 30" to 48" wide</p>	Shaped hinged doors	E2-OW-153016-SDT	14.75	30	16	46	798
		E2-OW-153616-SDT	14.75	36	16	53	870
		E2-OW-154216-SDT	14.75	42	16	60	935
		E2-OW-154816-SDT	14.75	48	16	67	985
	Pulls and Locks are not available on shaped doors						
 <p>Shaped hinged door Wall Mount, 54" or 60" wide</p>	Center shaped hinged doors	E2-OW-155416-SDT	14.75	54	16	74	1208
		E2-OW-156016-SDT	14.75	60	16	81	1245
	Pulls and Locks are not available on shaped doors						
 <p>Glass door WoodPlus² frame Wall Mount, 30" to 48" wide</p>	Glass doors	EQ-OW-153016-HGWT	14.75	30	16	46	1094
	WoodPlus² frame	EQ-OW-153616-HGWT	14.75	36	16	53	1178
		EQ-OW-154216-HGWT	14.75	42	16	60	1288
		EQ-OW-154816-HGWT	14.75	48	16	67	1455
	Two pair of doors	EQ-OW-155416-HGWT	14.75	54	16	74	1814
	EQ-OW-156016-HGWT	14.75	60	16	81	1852	
Pulls and Locks are not available on glass doors							

EQUATIONS² - Component Pricing

Description	Model	Dimensions			Wgt	List Prices WoodPlus ²
		Deep	Long	High		

E2 Overheads tackboards, wall mounted

Note: All fabrics are now installed on tackboards with the 'direction' vertical, i.e.the length of the fabric as it is pulled off the roll.

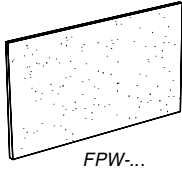

Tackboards	Model	Deep	Long	High	Wgt	List Prices	
18 high	FPW-30L-18H	0.5	30	18	5	222	
	FPW-36L-18H	0.5	36	18	5	222	
	FPW-42L-18H	0.5	42	18	5	222	
	FPW-48L-18H	0.5	48	18	5	222	
	FPW-54L-18H	0.5	54	18	10	222	
	FPW-60L-18H	0.5	60	18	10	222	
	FPW fabric panels that are 66" or longer are made in two pieces.						
		FPW-66L-18H	0.5	66	18	10	254
		FPW-72L-18H	0.5	72	18	10	254
		FPW-78L-18H	0.5	78	18	10	286
	FPW-84L-18H	0.5	84	18	10	286	
	FPW-90L-18H	0.5	90	18	10	286	
	FPW-96L-18H	0.5	96	18	10	286	

18" high panels fit between worktop and wall mounted overhead when overhead aligns with standard height hutch or 65 high tower.

Tackboards "FPW" are shipped in two pieces when 66" or longer.

Tackboards	Model	Deep	Long	High	Wgt	List Prices	
25 high	FPW-30L-25H	0.5	30	25	7	222	
	FPW-36L-25H	0.5	36	25	7	222	
	FPW-42L-25H	0.5	42	25	7	222	
	FPW-48L-25H	0.5	48	25	7	222	
	FPW-54L-25H	0.5	54	25	12	222	
	FPW-60L-25H	0.5	60	25	12	222	
	FPW fabric panels that are 66" or longer are made in two pieces.						
		FPW-66L-25H	0.5	66	25	12	254
		FPW-72L-25H	0.5	72	25	12	254
		FPW-78L-25H	0.5	78	25	12	286
	FPW-84L-25H	0.5	84	25	12	286	
	FPW-90L-25H	0.5	90	25	12	286	
	FPW-96L-25H	0.5	96	25	12	286	

25" high panels fit between worktop and wall mounted overhead when overhead aligns with extended height hutch or 72 high tower.

Tackboards "FPW" are shipped in two pieces when 66" or longer.

FPW- to 60" long - 18" or less in height	222
FPW- to 60" long - 25" or less in height	222
FPW- to 60" long - over 25" in height	254

Most standard Guilford Panel Fabrics are available on MagnaFLEX lead time.

If the fabric is not listed in our specifications (see www.magnadesign.com), please contact factory for Fabric Grade, availability, lead time and pricing.

Pricing shown is for Magna designated Fabric Grades A, B and C.

For COM fabric, please use the pricing shown above. A sample of the COM fabric plus the fabric specifications such as width of roll, directional or non-directional is required.

Tasklights are available in Accessories at back of pricelist.

EQUATIONS² - Component Pricing

Description	Model	Dimensions			Wgt	List Prices WoodPlus ²
		Deep	Long	High		



E2 Tables Mobiles



E2-TD-4629-COLX

Column base	E2-TD-4229-COLX	42	42	29	75	1010
	E2-TD-4629-COLX	46	46	29	93	1120

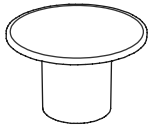

E2-TD-4629-CYL

Cylinder base	E2-TD-4229-CYL	42	42	29	140	1298
	E2-TD-4629-CYL	46	46	29	155	1384
	OPTION-GRC	1.75	3.5			48

For a center grommet in top, add ' -GRC' to the model name.

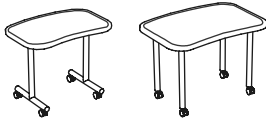

Kidney tables	E2-TK-243629-TLEG-CA	24	36	29	53	869
	E2-TK-304229-C2-CA	30	42	29	66	1031

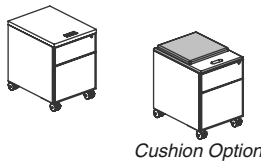

Cushion Option

Mobile 3/4 pedestal	E2-PM-211622-BF-CA	20	16	27	82	1190
	OPTION-EQ-PM-CUSHION	16	20	1	5	101

E2-PM Box File pedestal on casters with lock may be stored underneath a worktop.

Specify Pull.

Optional black cushion may be ordered for the top of the E2-PM case, add ' -CUSH' to model number.

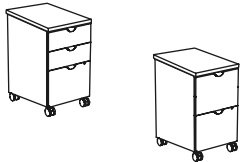

Worksurface height	E2-PD-TT-241629-BBF-CA	24	16	29	94	1261
	E2-PD-TT-241629-FF-CA	24	16	29	94	1261

E2-PD mobile pedestals include a worktop 24 deep and 16 wide.

E2-PD pedestal can be ' docked' next to a worktop to extend the worktop surface.

Specify Pull.

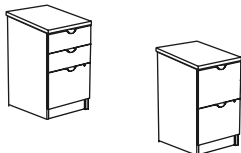

Pedestal with top	E2-PD-TT-241629-BBF	24	16	29	94	1035
	E2-PD-TT-241629-FF	24	16	29	94	1035

A worktop at 24 deep and 16 long is included.

This pedestal can be ' docked' next to a worktop to extend the worktop surface.

Specify Pull.

EQUATIONS² - Component Pricing

Description	Model	Dimensions			Wgt	List Prices WoodPlus ²
		Deep	Long	High		



Lateral File and Combo Components

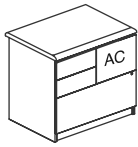

Combo A	E2-CR-TT-243229-AC	24	32	29	166	1532
----------------	---------------------------	----	----	----	-----	-------------

Includes one LF drawer and one File drawer, both locked.
Two Box drawers are not locked. Specify Pulls.

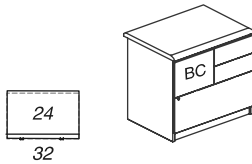

Combo B	E2-CR-TT-243229-BC	24	32	29	166	1532
----------------	---------------------------	----	----	----	-----	-------------

Includes one LF drawer and one File drawer, both locked.
Two Box drawers are not locked. Specify Pulls.

Freestanding Lateral
File cabinet, with lock

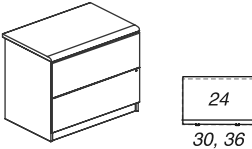

Lateral File	E2-CR-TT-243029-LF	24	30	29	162	1506
---------------------	---------------------------	----	----	----	-----	-------------

	E2-CR-TT-243629-LF	24	36	29	167	1561
--	---------------------------	----	----	----	-----	-------------

Two drawer lateral file cabinet with lock. Specify Pull.

Lateral File drawers with hutch storage above

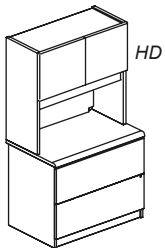

Hinged doors	E2-HL-TI-243065-HD-2LF	24	30	65	248	2553
---------------------	-------------------------------	----	----	----	-----	-------------

	E2-HL-TI-243665-HD-2LF	24	36	65	260	2622
--	-------------------------------	----	----	----	-----	-------------

65 high	OPTION-LOCK-PAIR-DOORS					87
----------------	-------------------------------	--	--	--	--	-----------

Two lateral file drawers are locked. Hutch has hinged doors. Specify Pull.
Overall height matches standard height hutch or bookcase at 65 high.

Hinged doors	E2-HL-TI-243072-HD-2LF	24	30	72	248	2634
---------------------	-------------------------------	----	----	----	-----	-------------

	E2-HL-TI-243672-HD-2LF	24	36	72	260	2714
--	-------------------------------	----	----	----	-----	-------------

72 high	OPTION-LOCK-PAIR-DOORS					87
----------------	-------------------------------	--	--	--	--	-----------

Two lateral file drawers are locked. Hutch has hinged doors. Specify Pull.
Overall height matches extended height hutch or bookcase at 72 high.

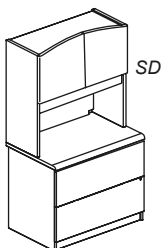

Shaped hinged doors 65 high	E2-HL-TI-243065-SD-2LF	24	30	65	250	2624
------------------------------------	-------------------------------	----	----	----	-----	-------------

	E2-HL-TI-243665-SD-2LF	24	36	65	262	2693
--	-------------------------------	----	----	----	-----	-------------

Two lateral file drawers are locked. Specify Pull.
Hutch has shaped hinged doors. No applied pull or lock available for shaped doors.
Overall height matches standard height hutch or bookcase at 65 high.

Shaped hinged doors 72 high	E2-HL-TI-243072-SD-2LF	24	30	72	250	2705
------------------------------------	-------------------------------	----	----	----	-----	-------------

	E2-HL-TI-243672-SD-2LF	24	36	72	262	2785
--	-------------------------------	----	----	----	-----	-------------

Two lateral file drawers are locked. Specify Pull.
Hutch has shaped hinged doors. No applied pull or lock available for shaped doors.
Overall height matches standard height hutch or bookcase at 72 high.

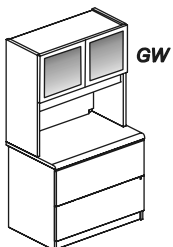

Glass doors 65 high	E2-HL-TI-243065-GW-2LF	24	30	65	248	2869
----------------------------	-------------------------------	----	----	----	-----	-------------

	E2-HL-TI-243665-GW-2LF	24	36	65	260	2939
--	-------------------------------	----	----	----	-----	-------------

Two lateral file drawers are locked. Specify Pull.
Hutch glass doors with WoodPlus2 frames. No applied pull or lock available for Glass doors.
Overall height matches standard height hutch or bookcase at 65 high.

Glass doors 72 high	E2-HL-TI-243072-GW-2LF	24	30	72	248	2951
----------------------------	-------------------------------	----	----	----	-----	-------------

	E2-HL-TI-243672-GW-2LF	24	36	72	260	3031
--	-------------------------------	----	----	----	-----	-------------

Two lateral file drawers are locked. Specify Pull.
Hutch glass doors with WoodPlus2 frames. No applied pull or lock available for Glass doors.
Overall height matches extended height hutch or bookcase at 72 high.

EQUATIONS² - Component Pricing

Description	Model	Dimensions			Wgt	List Prices WoodPlus ²
		Deep	Long	High		

E2 three and four drawer Lateral File cabinets



Three and Four Drawer
Lateral Files

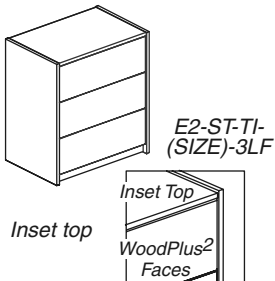

Inset top	E2-ST-TI-243041-3LF	24	30	41	284	2162
	E2-ST-TI-243641-3LF	24	36	41	292	2211

Three lateral file drawers are locked and are inset between tower ends. Specify Pull. Cabinet top is inset between ends. Cabinet top finish matches case finish.

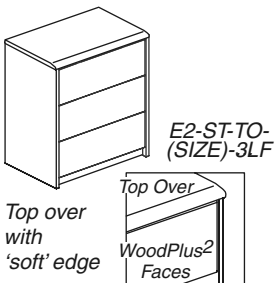

Top Over	E2-ST-TO-243041-3LF	24	30	41	284	2327
	E2-ST-TO-243641-3LF	24	36	41	292	2408

Three lateral file drawers are locked and are inset between tower ends. Specify Pull. Cabinet top over matches worktop finish and detailing.

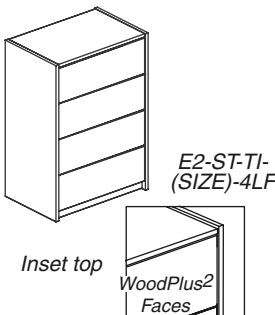

Inset top	E2-ST-TI-243053-4LF	24	30	53	288	2578
	E2-ST-TI-243653-4LF	24	36	53	301	2650

Four lateral file drawers are locked and are inset between tower ends. Specify Pull. Cabinet top is inset between ends. Cabinet top finish matches case finish.

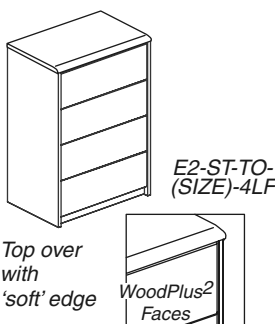

Top over	E2-ST-TO-243053-4LF	24	30	53	288	2760
	E2-ST-TO-243653-4LF	24	36	53	301	2842

Four lateral file drawers are locked and are inset between tower ends. Specify Pull. Cabinet top over matches worktop finish and detailing.

EQUATIONS² - Component Pricing

Description Model

Dimensions
Deep Long High

Wgt

 List Prices
WoodPlus²

E2 Bookcases

Bookcases

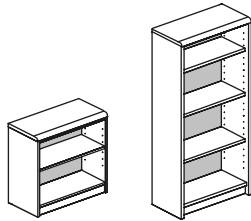

E2-ST-TO-(SIZE)-BCK

Description	Model	Deep	Long	High	Wgt	List Prices
Top over black back	E2-ST-TO-153029-BCK	15	30	29	89	779
	E2-ST-TO-153036-BCK	15	30	36	98	839
	E2-ST-TO-153042-BCK	15	30	42	108	866
	E2-ST-TO-153048-BCK	15	30	48	125	892
	E2-ST-TO-153060-BCK	15	30	60	140	919
	E2-ST-TO-153065-BCK	15	30	65	156	945
	E2-ST-TO-153072-BCK	15	30	72	156	991
	E2-ST-TO-153084-BCK	15	30	84	212	1036

Cabinet top over matches worktop finish and detailing.

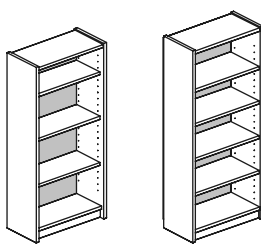

E2-ST-TI-(SIZE)-BCK

Top inset black back	E2-ST-TI-153036-BCK	15	30	36	98	733
	E2-ST-TI-153042-BCK	15	30	42	108	760
	E2-ST-TI-153048-BCK	15	30	48	125	786
	E2-ST-TI-153060-BCK	15	30	60	140	813
	E2-ST-TI-153065-BCK	15	30	65	156	839
	E2-ST-TI-153072-BCK	15	30	72	156	885
	E2-ST-TI-153084-BCK	15	30	84	212	930

Cabinet top is inset between ends. Cabinet top finish matches case finish.

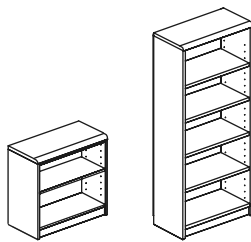

E2-ST-TO-(SIZE)-BCB

Top over matching back	E2-ST-TO-153029-BCB	15	30	29	89	825
	E2-ST-TO-153036-BCB	15	30	36	98	886
	E2-ST-TO-153042-BCB	15	30	42	108	946
	E2-ST-TO-153048-BCB	15	30	48	125	1007
	E2-ST-TO-153060-BCB	15	30	60	140	1067
	E2-ST-TO-153065-BCB	15	30	65	156	1132
	E2-ST-TO-153072-BCB	15	30	72	156	1177
	E2-ST-TO-153084-BCB	15	30	84	212	1223

Cabinet top over matches worktop finish and detailing.

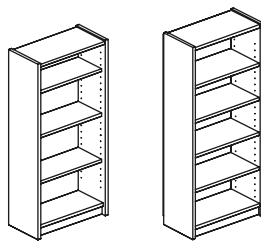

E2-ST-TI-(SIZE)-BCB

Top inset matching back	E2-ST-TI-153036-BCB	15	30	36	98	780
	E2-ST-TI-153042-BCB	15	30	42	108	840
	E2-ST-TI-153048-BCB	15	30	48	125	901
	E2-ST-TI-153060-BCB	15	30	60	140	961
	E2-ST-TI-153065-BCB	15	30	65	156	1026
	E2-ST-TI-153072-BCB	15	30	72	156	1071
	E2-ST-TI-153084-BCB	15	30	84	212	1117

Cabinet top is inset between ends. Cabinet top finish matches case finish.

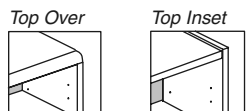
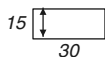

NOTES:

- 29 high matches worktop height.
- 29 high includes one adjustable shelf (does not accommodate two rows of binders)
- 36 high includes one adjustable shelf.
- 42, 48 high includes two adjustable shelves.
- 60, 65 high includes three adjustable shelves.
- 72 includes four adjustable shelves.
- 84 includes five adjustable shelves.

Adjustable shelves are 13 1/2" deep. Weight limit is 100 lbs per shelf.

36" wide bookcases are available at the same price, change the 30 to 36 in the model number.

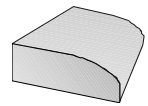

How to layout Equations² Shapes components

STEP 1: Layout Desks, Bridges, Returns, Credenzas, Overheads, Storage as needed using Equations² Shapes.

STEP 2: Support both ends of every Hutch,
Both ends of Bridge top connect to adjacent desks, credenzas or corners
One end of Return top connects to the adjacent desk, credenza or corner.

EXAMPLES:

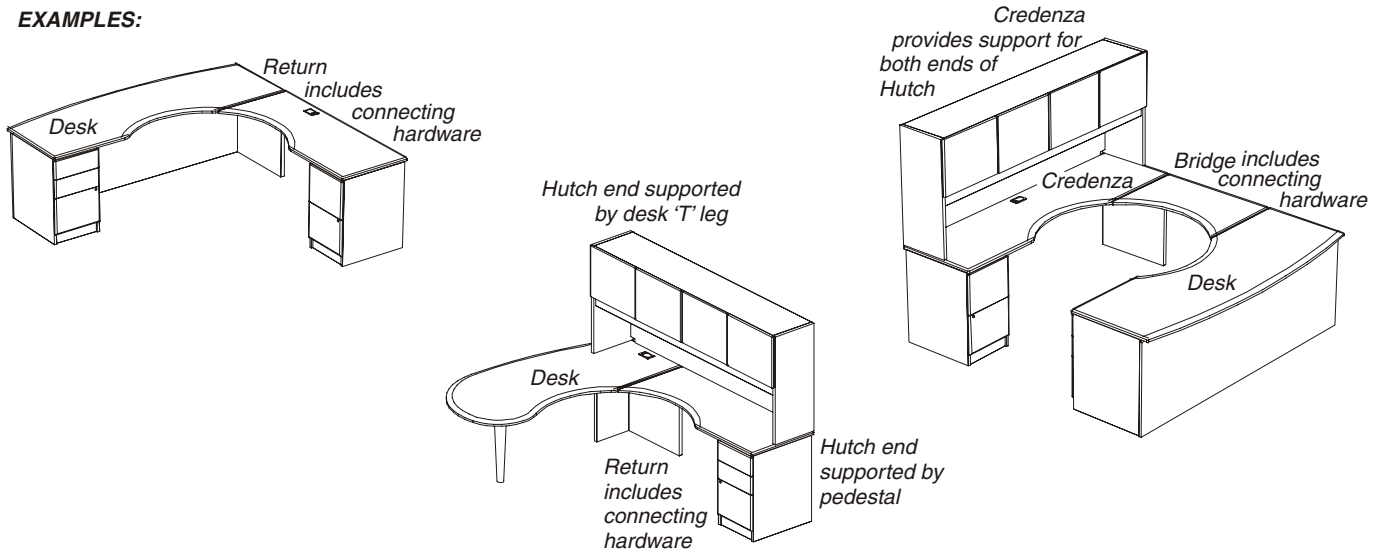

STEP 3: Answer the Specification questions for all components

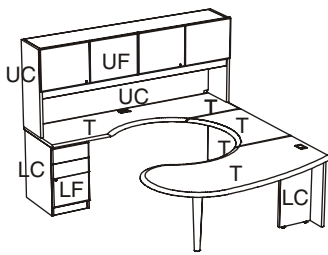
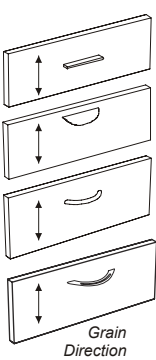
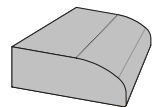
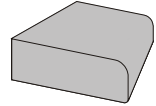
<p>Please Specify :</p> <p><u>for Worktops</u> T - Worktop finish</p> <p><u>for Lowers</u> LC - Cabinet case, Modesty Panels, End Panels finish LF - lower face finish - Pull number</p> <p><u>for Hutches/Overheads</u> UC - Top, ends and back finish UF - upper doors, tower doors finish Pull number</p> 	<p>Available Finishes:</p> <p>Worktops, Drawer & Door Faces:</p> <table border="0"> <tr> <td>WoodPlus²</td> <td>WoodPlus² XTRAS*</td> </tr> <tr> <td>WP2-45 Anigre</td> <td>WP2-65 Beech</td> </tr> <tr> <td>WP2-71 Dark Cherry</td> <td>CP2-78 Bronze</td> </tr> <tr> <td>WP2-81 Fusion Maple</td> <td>CP2-74 Platinum</td> </tr> <tr> <td>WP2-31 Medium Cherry</td> <td>WP2-75 Port</td> </tr> <tr> <td>WP2-41 Natural Maple</td> <td>WP2-18 Shadow Oak</td> </tr> <tr> <td>WP2-61 Pear</td> <td></td> </tr> <tr> <td>WP2-23 Cordovan</td> <td></td> </tr> </table> <p>*XTRA finishes add \$600 per finish per order</p> <p>ColorPlus² CP2-28 Med. Gray Speckle CP2-38 Beige Speckle</p> <p>Cabinet Cases, Modesty Panels, End Panels, Hutch/Overhead Tops, ends and backs.</p> <table border="0"> <tr> <td>WoodPlus</td> <td>ColorPlus</td> </tr> <tr> <td>WP-45 Anigre</td> <td>CP-76 Espresso</td> </tr> <tr> <td>WP-71 Dark Cherry</td> <td>CP-88 Black</td> </tr> <tr> <td>WP-81 Fusion Maple</td> <td>CP-98 Slate</td> </tr> <tr> <td>WP-31 Medium Cherry</td> <td></td> </tr> <tr> <td>WP-41 Natural Maple</td> <td></td> </tr> <tr> <td>WP-61 Pear</td> <td></td> </tr> <tr> <td>WP-23 Cordovan</td> <td></td> </tr> </table> <p>Column Supports</p> <table border="0"> <tr> <td>P1 Black</td> <td>P8 Silver</td> </tr> </table>	WoodPlus²	WoodPlus² XTRAS*	WP2-45 Anigre	WP2-65 Beech	WP2-71 Dark Cherry	CP2-78 Bronze	WP2-81 Fusion Maple	CP2-74 Platinum	WP2-31 Medium Cherry	WP2-75 Port	WP2-41 Natural Maple	WP2-18 Shadow Oak	WP2-61 Pear		WP2-23 Cordovan		WoodPlus	ColorPlus	WP-45 Anigre	CP-76 Espresso	WP-71 Dark Cherry	CP-88 Black	WP-81 Fusion Maple	CP-98 Slate	WP-31 Medium Cherry		WP-41 Natural Maple		WP-61 Pear		WP-23 Cordovan		P1 Black	P8 Silver	<p>Pull Numbers:</p>  <p>#10 Black Chrome #12 Black #13 Satin Chrome #14 Black #15 Satin Chrome #18 Black #19 Satin Chrome #14, 15, 18, 19 are ADA compliant</p> <p>WoodPlus² work tops combine:</p> <p>User edge </p> <p>Joint and hutch edge </p> <p>See drawings for details</p>
WoodPlus²	WoodPlus² XTRAS*																																			
WP2-45 Anigre	WP2-65 Beech																																			
WP2-71 Dark Cherry	CP2-78 Bronze																																			
WP2-81 Fusion Maple	CP2-74 Platinum																																			
WP2-31 Medium Cherry	WP2-75 Port																																			
WP2-41 Natural Maple	WP2-18 Shadow Oak																																			
WP2-61 Pear																																				
WP2-23 Cordovan																																				
WoodPlus	ColorPlus																																			
WP-45 Anigre	CP-76 Espresso																																			
WP-71 Dark Cherry	CP-88 Black																																			
WP-81 Fusion Maple	CP-98 Slate																																			
WP-31 Medium Cherry																																				
WP-41 Natural Maple																																				
WP-61 Pear																																				
WP-23 Cordovan																																				
P1 Black	P8 Silver																																			

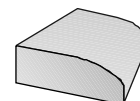

How to layout Equations² Shapes components

Equations² Shapes available grommet locations

Rectangular Desk worktops , 30" deep

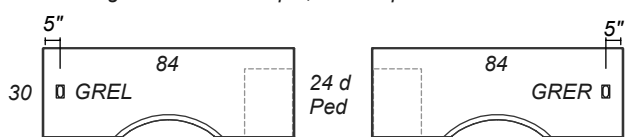

Rectangular Desk worktops , 36" deep

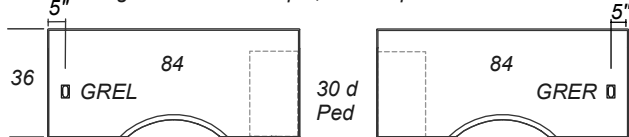

Bow Front Desk worktops , 30" deep

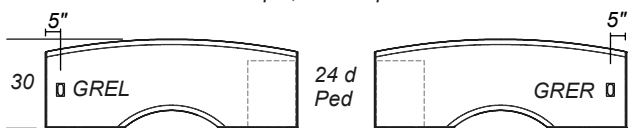

Bow Front Desk worktops , 36" deep

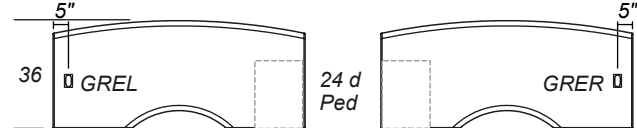

Comma Desk worktops

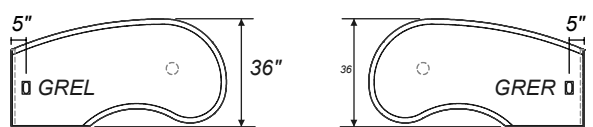

Return worktops, 24" deep

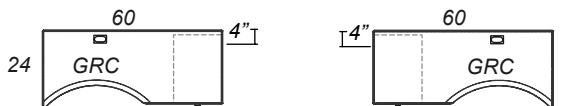

Bridge worktops, 24" deep

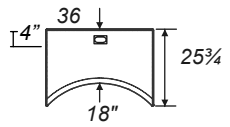
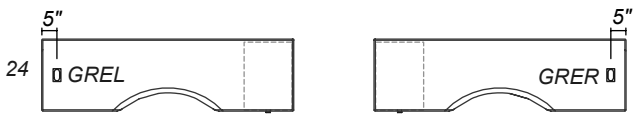

Table Desk, 30" deep



Rectangular Credenza worktops, 24" deep



Tapered Leg Option

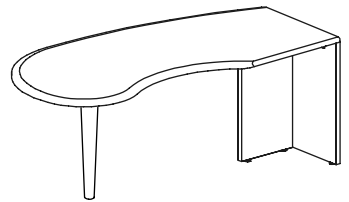

with Tapered Leg (optional)

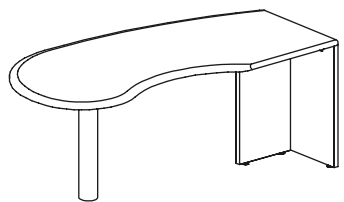

with 4" column base (default)

Note that the Equations² Shapes credenza in the U 'cockpit' station has a 'joint' edge over the pedestal and the worksurface on the adjacent lateral file credenza has an 'ergo' edge along the user side. This creates a mis-matched joint. Please order the lateral file credenza with a 'joint' edge along the user side.

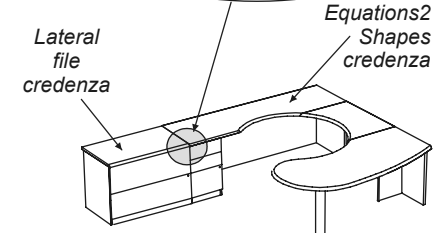



EQUATIONS² Shapes - Configuration Examples

Equations2 Shapes WoodPlus2 Configurations

WoodPlus² is a polymer material thermoformed under pressure and vacuum into a seamless, one-piece surface with an integrated edge.

WoodPlus² Worktops include both:

user edge

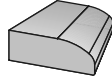

joint or hutch edge

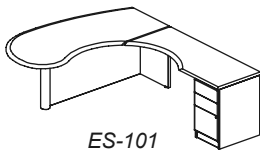
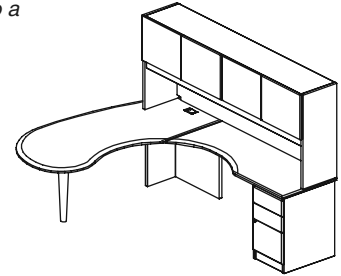
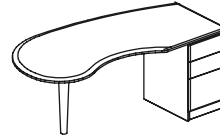
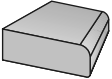

ES-101

ES Shapes Configuration ES-101

ES-D-CO-367229-C4-MP-R	Desk, comma top	1414
ES-R-RCP-246029-BBF-R	Return with Box Box File pedestal	1495
Total Price		2909

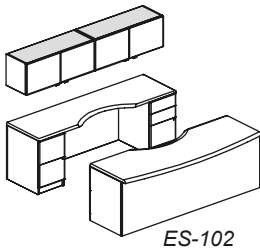

ES-102

ES Shapes Configuration ES-102

ES-D-BCP-308429-FF-MP-BBF	Desk, Bow front, File File and Box Box File pedestals	2858
ES-CR-TCP-248429-FF-BBF	Credenza, File File and Box Box File pedestals	2555
E2-MP-8429-HORZ	Modesty Panel for credenza	168
E2-OW-154216-HDT	Overhead, wall mounted, hinged door Tech cabinet	864
E2-OW-154216-HDT	Overhead, wall mounted, hinged door Tech cabinet	864
Total Price		7309

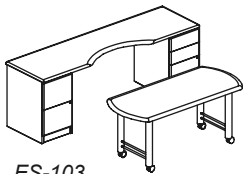

ES-103

ES Shapes Configuration ES-103

ES-D-TBE-305429-H2-CA	Desk, Hlegs, casters	1246
ES-CR-TCP-248429-FF-BBF	Credenzas with File File and Box Box File pedestals	2555
Total Price		3801

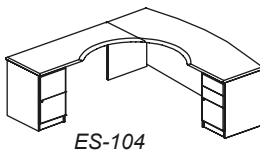

ES-104

ES Shapes Configuration ES-104

ES-D-BCP-308429-BBF-MP	Desk, bow front, 30 x 84 with Box Box File pedestal	2206
ES-R-RCP-246029-FF-L	Return with File File pedestal	1495
Total Price		3701

Note: beginning with this price list the LEFT / RIGHT layout of our Equations2 Shapes RETURNS are LEFT when the return is to the LEFT of the user when seated at the desk and RIGHT when the return is to the RIGHT of the user.



EQUATIONS² Shapes - Configuration Examples

ES Shapes Configuration ES-105

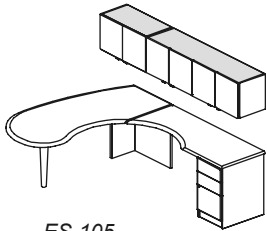

ES-105

ES-D-CO-367229-C4-R	Desk, Comma top	1414
OPTION-TAPERED-LEG	Desk option: tapered leg	78
ES-R-RCP-246029-BBF-R	Return with Box Box File pedestal	1495
E2-OW-153016-HDT	Overhead, wall mounted, hinged door 30 long	727
E2-OW-156016-HDT	Overhead, wall mounted, hinged door 60 long	1174
Total Price		4888

ES Shapes Configuration ES-106

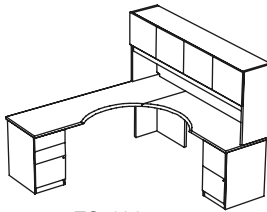

ES-106

ES-CR-TCP-308429-BBF	Desk 30 x 84, with Box Box File pedestal	2135
ES-R-RCP-246029-FF-R	Return with File File pedestal	1495
ES-H-TI-159035-HD	Hutch hinged door	2284
E2-EP-1429	Support panel for hutch end	196
Total Price		6110

ES Shapes Configuration ES-107

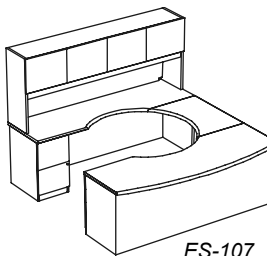

ES-107

ES-D-BCP-308429-BBF-MP	Desk, bow front, 30 x 84 with Box Box File pedestal	2206
ES-B-BCP-243629	Bridge	358
ES-CR-TCP-248429-FF	Credenza with File File pedestal	1908
E2-MP-8429-HORZ	Modesty Panel for credenza	168
ES-H-TI-158435-HD	Hutch hinged door	2188
Total Price		6828

ES Shapes Configuration ES-108

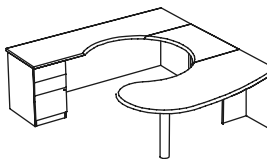

ES-108

ES-D-CO-367229-C4-L	Desk, comma top, 36 x 72	1414
ES-B-BCP-243629	Bridge	358
ES-CR-TCP-248429-BBF	Credenza with Box Box File pedestal	1908
E2-MP-8429-HORZ	Modesty Panel for credenza	168
Total Price		3848

ES Shapes Configuration ES-109

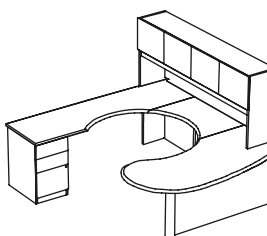

ES-109

ES-D-CO-367229-C4-MP-L	Desk, comma top, with column and modesty panel	1414
ES-B-BCP-243629	Bridge	358
ES-CR-TCP-308429-BBF	Credenza with Box Box File pedestal	2135
ES-H-TI-158435-HD	Hutch hinged door	2188
E2-EP-1429	Support panel for hutch end	196
Total Price		6291

Note: beginning with this price list the LEFT / RIGHT layout of our Equations² Shapes RETURNS are
 LEFT when the return is to the LEFT of the user when seated at the desk and
 RIGHT when the return is to the RIGHT of the user.

EQUATIONS² Shapes - Component Pricing

Comma Desks

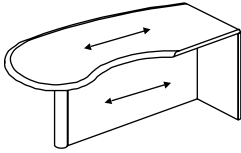

"ES Shapes Comma desks" on page 81

Table Desk

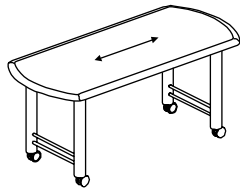

"ES Shapes Table desk" on page 81

Bow Front Desks

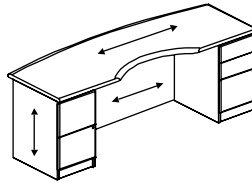

"ES Shapes Bow desk, double pedestal" on page 82

Bow Front Desks

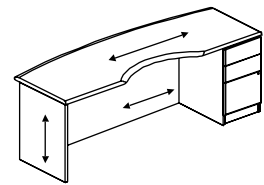

"ES Shapes Bow desk, L or U configuration" on page 82

Rectangular Desks

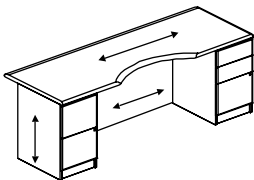

"ES Shapes Desk, double pedestal" on page 83

Return with Pedestal

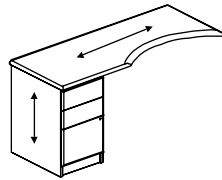

"ES Shapes Return with Pedestal" on page 84

Return with Lateral File

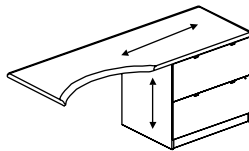

"ES Shapes Return with Pedestal" on page 84

Return with Combo cabinet

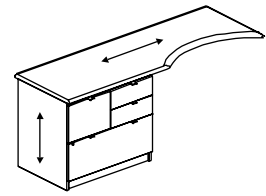

"ES Shapes Return with Pedestal" on page 84

Bridge Top

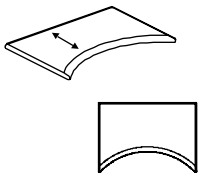

"ES Shapes Bridge" on page 83

Credenza with Lateral File

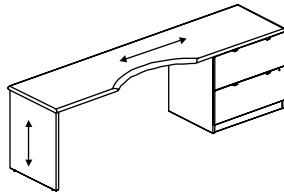

"ES Shapes Credenza with Combo cabinet" on page 85

Credenza with Pedestal

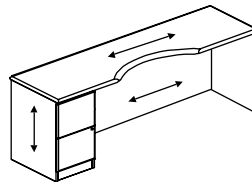

"ES Shapes Credenza, U station" on page 85

Credenza with Pedestal, Combo cabinet

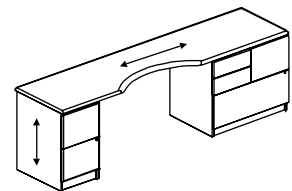

"ES Shapes Credenza, freestanding" on page 86

Shaped Hinged Door Hutch

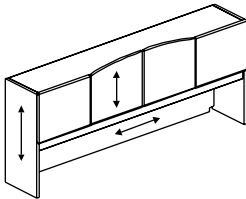

"ES Shapes Hutches" on page 87

Combo cabinet

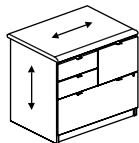

"Lateral File and Combo Components" on page 91

Lateral File and Hutch

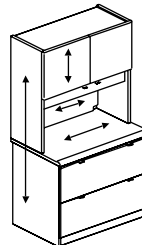

"Lateral File drawers with hutch storage above" on page 91

Lateral File cabinets

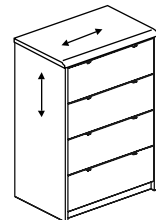

"Three and four drawer Lateral File cabinets" on page 92

EQUATIONS² Shapes - Component Pricing

Description	Model	Dimensions			Wgt	List Prices WoodPlus ²
		Deep	Long	High		

ES Shapes Comma desks

Comma Desks

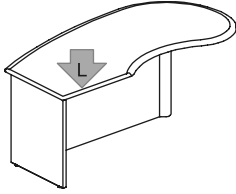

Return Left	ES-D-CO-367229-C4-MP-L	36	72	29	164	1414
--------------------	-------------------------------	----	----	----	-----	-------------

Available with 4" diameter column only.
Connecting top is to the LEFT of the user.
Must be used in an L or U layout. NOT freestanding.

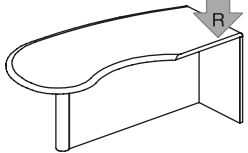

Return Right	ES-D-CO-367229-C4-MP-R	36	72	29	164	1414
---------------------	-------------------------------	----	----	----	-----	-------------

Available with 4" diameter column only.
Connecting top is to the RIGHT of the user.
Must be used in an L or U layout. NOT freestanding.

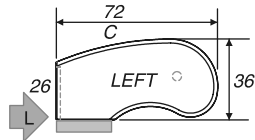

Return Left	ES-D-CO-367229-C4-L	36	72	29	148	1414
--------------------	----------------------------	----	----	----	-----	-------------

Standard with 4" diameter column.
Connecting top is to the LEFT of the user.
Must be used in an L or U layout. NOT freestanding.

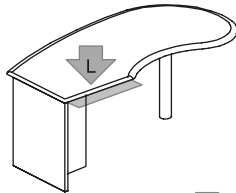

Return Right	ES-D-CO-367229-C4-R	36	72	29	148	1414
---------------------	----------------------------	----	----	----	-----	-------------

Standard with 4" diameter column.
Connecting top is to the RIGHT of the user.
Must be used in an L or U layout.

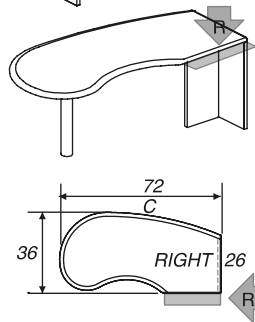

Option	OPTION-TAPERED-LEG					78
---------------	---------------------------	--	--	--	--	-----------

OPTION-GRE **48**
Tapered Leg is only available on Desk without MP modesty panel.D
Desk with tapered leg must be part of L or U layout.

ES Shapes Table desk

Table Desk

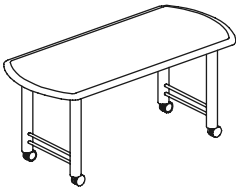
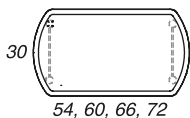

Table desk	ES-D-TBE-305429-H2-CA	30	54	29	101	1246
	ES-D-TBE-306029-H2-CA	30	60	29	105	1274
	ES-D-TBE-306629-H3-CA	30	66	29	108	1376
	ES-D-TBE-307229-H3-CA	30	72	29	115	1443

54 and 60 lengths have 2 inch diameter legs with casters.
66 and 72 lengths have 3 inch diameter legs with casters.
Specify leg finish: P1 Black or P8 Silver
Bow end of table desk matches the credenzas on the following pages to form a video station.



EQUATIONS² Shapes - Component Pricing

Description	Model	Dimensions			Wgt	List Prices WoodPlus ²
		Deep	Long	High		



ES Shapes Bow desk, L or U configuration

Single Pedestal Bow
Front Desks for use
with Return or Bridge

30 deep	ES-D-BCP-308429-BBF-MP	30	84	29	240	2206
----------------	-------------------------------	----	----	----	-----	-------------

24 deep Box Box File pedestal with lock.
Modesty panel is recessed 6 inches at deepest part of bow.

This unit is not handed.

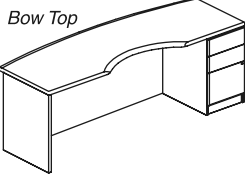

Bow Top

36 deep	ES-D-BCP-368429-BBF-MP	36	84	29	255	2379
----------------	-------------------------------	----	----	----	-----	-------------

30 deep Box Box File pedestal with lock. Specify Pull.
Modesty panel is recessed 12 inches at deepest part of bow and 6 inches at ends of top.

This unit is not handed.

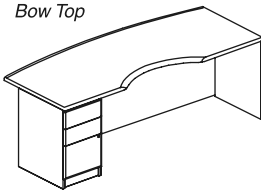

Bow Top

Options	OPTION-GRE-GROMMET					48
----------------	---------------------------	--	--	--	--	-----------

To order a worktop grommet to the LEFT of the user, add ' -GREL' to the model number .
To order a worktop grommet to the RIGHT of the user, add ' -GRER' to the model number .
When adding either the GREL or GRER grommet to this top, the top becomes ' handed' .

ES Shapes Bow desk, double pedestal

Double Pedestal Bow
Front Desks

30 deep	ES-D-BCP-308429-FF-MP-BBF	30	84	29	298	2858
----------------	----------------------------------	----	----	----	-----	-------------

24 deep Box Box File pedestal with lock and File File pedestal with lock. Specify Pull.
Modesty panel is recessed 6 inches at deepest part of bow.
This unit is not handed.

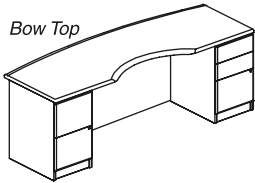

Bow Top

36 deep	ES-D-BCP-368429-FF-MP-BBF	36	84	29	313	3020
----------------	----------------------------------	----	----	----	-----	-------------

24 deep Box Box File pedestal with lock and File File pedestal with lock. Specify Pull.
Modesty panel is recessed 12 inches at deepest part of bow and 6 inches behind pedestals.
This unit is not handed.

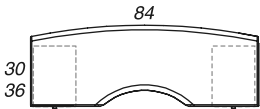

30
36

84

ES Shapes Desk, L or U configuration

Single Pedestal Desks
for use with Return or
Bridge

30 deep	ES-D-TCP-308429-BBF-MP	30	84	29	243	2206
----------------	-------------------------------	----	----	----	-----	-------------

24 deep Box Box File pedestal with lock. Specify Pull.
Modesty panel is recessed 6 inches.

This unit is not handed.

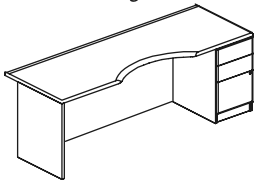

36 deep	ES-D-TCP-368429-BBF-MP	36	84	29	261	2368
----------------	-------------------------------	----	----	----	-----	-------------

30 deep Box Box File pedestal with lock. Specify Pull.
Modesty panel is recessed 6 inches.

This unit is not handed.

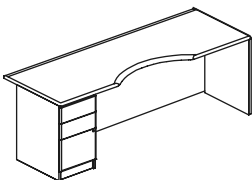

Option						
---------------	--	--	--	--	--	--

To order a worktop grommet to the LEFT of the user, add ' -GREL' to the model number .
To order a worktop grommet to the RIGHT of the user, add ' -GRER' to the model number .
When adding either the GREL or GRER grommet to this top, the top becomes ' handed' .

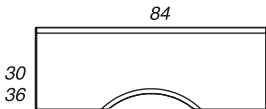

30
36

84

EQUATIONS² Shapes - Component Pricing

Description	Model	Dimensions			Wgt	List Prices WoodPlus ²
		Deep	Long	High		



ES Shapes Desk, double pedestal

Double Pedestal Desk
30" or 36" deep

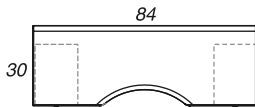
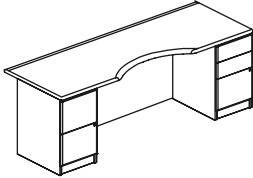

30 deep	ES-D-TCP-308429-FF-MP-BBF	30	84	29	301	2858
----------------	----------------------------------	----	----	----	-----	-------------

24 deep Box Box File pedestal with lock and File File pedestal with lock. Specify Pull. Modesty panel is recessed 6 inches.

This unit is not handed.

36 deep	ES-D-TCP-368429-FF-MP-BBF	36	84	29	313	3020
----------------	----------------------------------	----	----	----	-----	-------------

30 deep Box Box File pedestal with lock and File File pedestal with lock. Specify Pull. Modesty panel is recessed 12 inches at deepest part of bow and 6 inches behind pedestals.

This unit is not handed.

ES Shapes Bridge

Bridge, 36" long

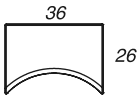
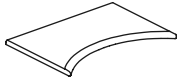

Bridge	ES-B-BCP-243629	24	36	29	33	358
---------------	------------------------	----	----	----	----	------------

Bridge includes hardware to connect to both ends to desk or credenza.

Option	OPTION-MP-BRIDGE					168
---------------	-------------------------	--	--	--	--	------------

Vertical Grain. To order a modesty panel, add '-MP' to model number.

EQUATIONS² Shapes - Component Pricing

Description	Model	Dimensions			Wgt	List Prices WoodPlus ²
		Deep	Long	High		



ES Shapes Return with Pedestal

Note: beginning with this price list the LEFT / RIGHT layout of our Equations² Shapes RETURNS are LEFT when the return is to the LEFT of the user when seated at the desk and RIGHT when the return is to the RIGHT of the user.

Returns, with Pedestal,

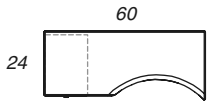
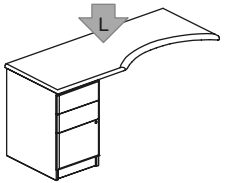
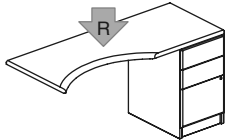

Left of desk	ES-R-RCP-246029-BBF-L	24	60	29	135	1495
	ES-R-RCP-247229-BBF-L	24	72	29	144	1603

Box Box File pedestal with lock. Specify Pull.

Right of desk	ES-R-RCP-246029-BBF-R	24	60	29	135	1495
	ES-R-RCP-247229-BBF-R	24	72	29	144	1603

Box Box File pedestal with lock. Specify Pull.

Left of desk	ES-R-RCP-246029-FF-L	24	60	29	135	1495
	ES-R-RCP-247229-FF-L	24	72	29	144	1603

File File pedestal with lock. Specify Pull.

Right of desk	ES-R-RCP-246029-FF-R	24	60	29	135	1495
	ES-R-RCP-247229-FF-R	24	72	29	144	1603

File File pedestal with lock. Specify Pull.

Returns, with Cabinet,

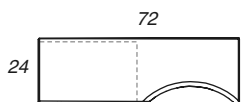
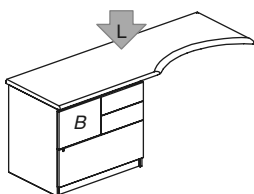
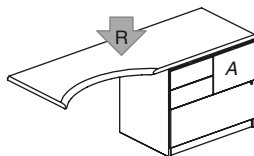
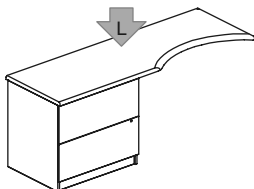
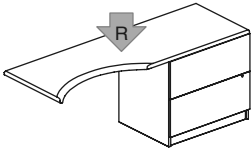

2LF	ES-R-RCP-247229-LF-L	24	72	29	197	1900
------------	-----------------------------	----	----	----	-----	-------------

Left of desk 30 wide two drawer lateral file cabinet with lock. Specify Pull.

2LF	ES-R-RCP-247229-LF-R	24	72	29	197	1900
------------	-----------------------------	----	----	----	-----	-------------

Right of desk 30 wide two drawer lateral file cabinet with lock. Specify Pull.

Combo A	ES-R-RCP-247229-AC-R	24	72	29	197	1900
----------------	-----------------------------	----	----	----	-----	-------------

Right of desk Combo-A cabinet with lock on lateral file and file drawers. Two box drawer do not lock. Specify Pull.

Combo B	ES-R-RCP-247229-BC-L	24	72	29	197	1900
----------------	-----------------------------	----	----	----	-----	-------------

Left of desk Combo-B cabinet with lock on lateral file and file drawers. Two box drawer do not lock. Specify Pull.

Returns include hardware to connect to desk or credenza.

Option	OPTION-MP-RETURN					168
---------------	-------------------------	--	--	--	--	------------

Add ' -MP' to order optional Modesty Panel on return

EQUATIONS² Shapes - Component Pricing

Description	Model	Dimensions			Wgt	List Prices WoodPlus ²
		Deep	Long	High		



ES Shapes Credenza, U station

Single Pedestal
Credenzas, 84" long, for
use with Return or Bridge

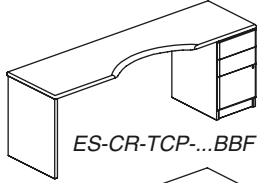

ES-CR-TCP-...BBF

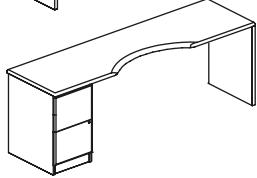

Box Box File pedestal	ES-CR-TCP-248429-BBF	24	84	29	181	1908
	ES-CR-TCP-308429-BBF	30	84	29	200	2135

Box Box File pedestal with lock. Pedestal depth matches top depth. Specify Pull.

This unit is not handed.

File File pedestal	ES-CR-TCP-248429-FF	24	84	29	181	1908
	ES-CR-TCP-308429-FF	30	84	29	200	2135

File File pedestal with lock. Pedestal depth matches top depth. Specify Pull.

This unit is not handed.

Option	OPTION-MP-CREDENZA					168
	OPTION-GRE-GROMMET					48

To order a worktop grommet to the LEFT of the user, add ' -GREL' to the model number .

To order a worktop grommet to the RIGHT of the user, add ' -GRER' to the model number .

When adding either the GREL or GRER grommet to this top, the top becomes ' handed' .

To order a modesty panel, add ' -MP' to the model number.

ES Shapes Credenza with Combo cabinet

Single Cabinet
Credenzas, 96" long, for
use with Return or Bridge

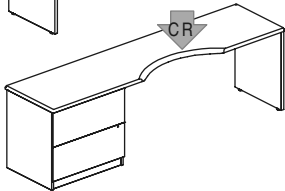
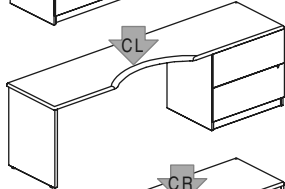
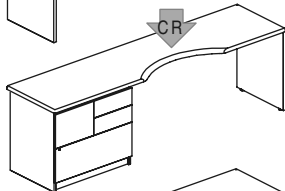
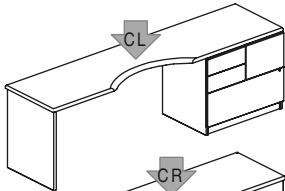

Return or Bridge to LEFT of user	ES-CR-TCP-249629-AC-CL	24	96	29	242	2389
	ES-CR-TCP-309629-AC-CL	30	96	29	267	2616

Combo-A cabinet with lock on lateral file and file drawers.

Two box drawer do not lock. Specify pulls.

CL = Bridge or Return is to the LEFT of the user when seated at this unit.

Return or Bridge to RIGHT of user	ES-CR-TCP-249629-BC-CR	24	96	29	242	2389
	ES-CR-TCP-309629-BC-CR	30	96	29	267	2616

Combo-B cabinet with lock on lateral file and file drawers.

Two box drawer do not lock. Specify pulls.

CR = Bridge or Return is to the RIGHT of the user when seated at this unit.

Return or Bridge to LEFT of user	ES-CR-TCP-249629-LF-CL	24	96	29	263	2391
	ES-CR-TCP-309629-LF-CL	30	96	29	288	2618

File File Pedestal with lock and 30" wide Lateral File with lock. Specify Pull.

Pedestal and Lateral File depth matches top depth.

CL = Bridge or Return is to the LEFT of the user when seated at this unit.

Return or Bridge to RIGHT of user	ES-CR-TCP-249629-LF-CR	24	96	29	263	2391
	ES-CR-TCP-309629-LF-CR	30	96	29	288	2618

File File Pedestal with lock and 30" wide Lateral File with lock. Specify Pull.

Pedestal and Lateral File depth matches top depth.

CR = Bridge or Return is to the RIGHT of the user when seated at this unit.

On ES Credenzas at 96" long
CL means the Bridge or Return
is to the LEFT of user
CR means the Bridge or Return
is to the RIGHT of user.

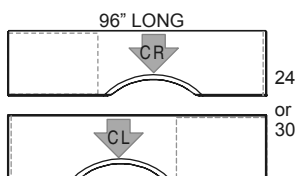

Options	OPTION-MP-CREDENZA					168
	OPTION-GRE-GROMMET					48

To order a worktop grommet to the LEFT of the user, add ' -GREL' to the model number .

To order a worktop grommet to the RIGHT of the user, add ' -GRER' to the model number .

To order a modesty panel, add ' -MP' to the model number.

EQUATIONS² Shapes - Component Pricing

Description Model Dimensions Deep Long High Wgt List Prices WoodPlus²

ES Shapes Credenza, freestanding

Freestanding Credenzas, 84" long

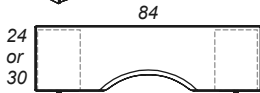
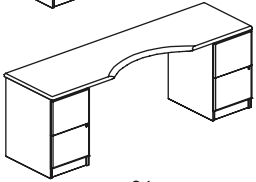
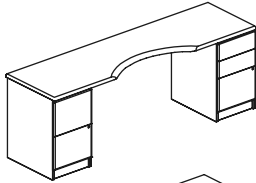

BBF and FF	ES-CR-TCP-248429-FF-BBF	24	84	29	237	2555
	ES-CR-TCP-308429-FF-BBF	30	84	29	250	2771

Box Box File pedestal with lock and File File pedestal with lock. Specify Pull.
Pedestal depths match top depth.
When installed, pedestals may be placed at either end.

FF and FF	ES-CR-TCP-248429-FF-FF	24	84	29	237	2555
	ES-CR-TCP-308429-FF-FF	30	84	29	250	2771

Two File File pedestals with lock.. Specify Pull.
Pedestal depths match top depth.

Freestanding Credenzas, 96" long

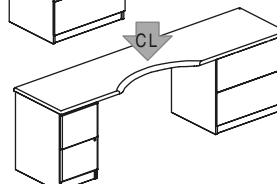
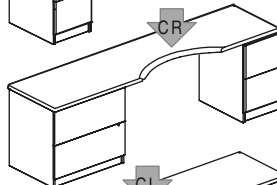
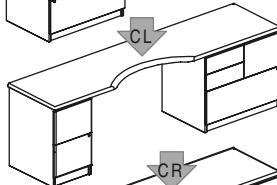
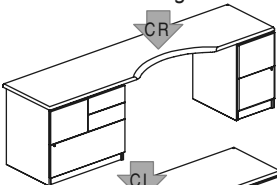

Cutout in top to Right	ES-CR-TCP-249629-BC-FF-CR	24	96	29	299	3041
	ES-CR-TCP-309629-BC-FF-CR	30	96	29	318	3257

File File pedestal with lock. Specify Pull.
Combo-B cabinet with lock on lateral file and file drawers. Two box drawer do not lock.
Pedestal depth and Combo-B cabinet depth match top depth.
RIGHT = Cutout in top is Right of center, so the pedestal is at the Right end..

Cutout in top to LEFT	ES-CR-TCP-249629-AC-FF-CL	24	96	29	299	3041
	ES-CR-TCP-309629-AC-FF-CL	30	96	29	318	3257

File File pedestal with lock. Specify Pull.
Combo-A cabinet with lock on lateral file and file drawers. Two box drawer do not lock.
Pedestal depth and Combo-B cabinet depth match top depth.
LEFT = Cutout in top is Left of center, so the pedestal is at the Left end.

Cutout in top to Right	ES-CR-TCP-249629-LF-FF-CR	24	96	29	299	3041
	ES-CR-TCP-309629-LF-FF-CR	30	96	29	318	3257

File File pedestal with lock. Lateral File with lock. Specify Pull.
Pedestal depth and Lateral File depth match top depth.
RIGHT = Cutout in top is Right of center, so the pedestal is at the Right end.

Cutout in top to Left	ES-CR-TCP-249629-LF-FF-CL	24	96	29	299	3041
	ES-CR-TCP-309629-LF-FF-CL	30	96	29	318	3257

File File pedestal with lock. Lateral File with lock. Specify Pull.
Pedestal depth and Lateral File depth match top depth.
LEFT = Cutout in top is Left of center, so the pedestal is at the Left end.

On ES Credenzas at 96" long
CL means the Bridge or Return is to the LEFT of user
CR means the Bridge or Return is to the RIGHT of user.

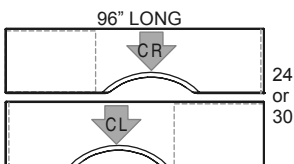

Option	OPTION-MP-CREDENZA					168
--------	--------------------	--	--	--	--	-----

To order a modesty panel, add ' -MP' to the model number.

EQUATIONS² Shapes - Component Pricing

Description Model

Dimensions
Deep Long High

Wgt

 List Prices
WoodPlus²

ES Shapes Hutches

Equations² Shapes
Hutches

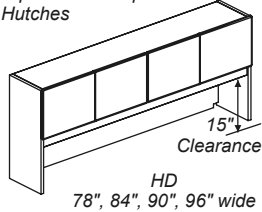

Description	Model	Deep	Long	High	Wgt	List Prices WoodPlus ²
Hinged Doors	ES-H-TI-158435-HD	15	84	36	182	2188
	ES-H-TI-159035-HD	15	90	35	192	2284
	ES-H-TI-159635-HD	15	96	35	192	2284

Options

LOCK-TWO-PR-HINGED-DOORS

174

Add ' -LOCK' to model number to lock both pairs of doors.

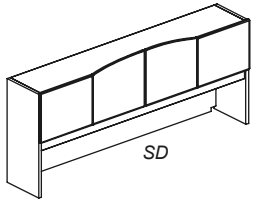

Description	Model	Deep	Long	High	Wgt	List Prices WoodPlus ²
Shaped Doors	ES-H-TI-158435-SD	15	84	36	182	2312
	ES-H-TI-159035-SD	15	90	35	192	2428
	ES-H-TI-159635-SD	15	96	35	182	2428

No lock and no applied pull available for hutches with shaped doors.

Glass Doors, WoodPlus² Frames

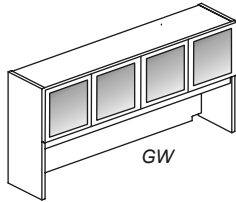

Description	Model	Deep	Long	High	Wgt	List Prices WoodPlus ²
Glass Doors	ES-H-TI-158435-GW	15	84	36	182	2819
WoodPlus ² frames	ES-H-TI-159035-GW	15	90	35	192	2913
	ES-H-TI-159635-GW	15	96	35	192	2913

Applied pulls and locks not available on Glass Doors.

GW = Glass doors with WoodPlus² frame. GW doors use frosted glass.

For clear glass, please add List \$210 per unit and add ' -CLEAR' to model number.

All Equations² Hutch doors fully overlay the hutch case.

Fabric Tackboards for Hutches

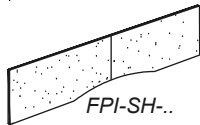
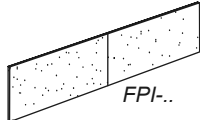

Description	Model	Deep	Long	High	Wgt	List Prices WoodPlus ²
Tackboards for hutch	FPI-84L-35H	0.5	81	17.5	13	286
	FPI-90L-35H	0.5	87	17.5	14	286
	FPI-96L-35H	0.5	93	17.5	15	286

Use with EQ2S standard hinged door or shaped door hutches.

Description	Model	Deep	Long	High	Wgt	List Prices WoodPlus ²
Tackboards	FPI-SH-84L-35H	0.5	81	17.5	13	286
Shaped Doors	FPI-SH-90L-35H	0.5	87	17.5	14	286
	FPI-SH-96L-35H	0.5	93	17.5	15	286

Use with EQ2S shaped door hutches; curve of FPI-SH mimics shaped door curve.

For COM fabric, please use the pricing shown above. A sample of the COM fabric plus the fabric specifications such as width of roll, directional or non-directional is required.

RTA option

Ship any hutch RTA (ready to assemble), all hardware is included, all holes pre-bored, available at no additional charge. Add "RTA" to the beginning of the model number. Add FPI to cover exposed fasteners.

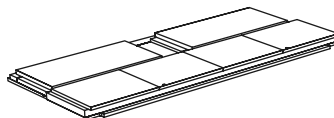

Shipped RTA (Ready to Assemble)

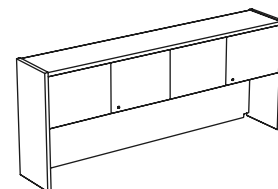

Assembled on site

EQUATIONS² Shapes - Component Pricing

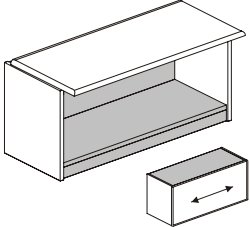
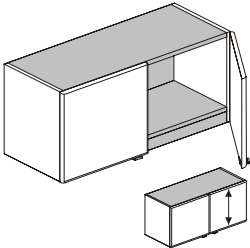
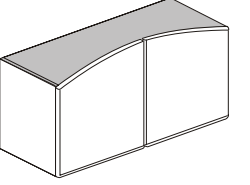
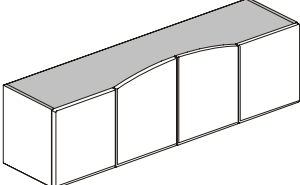
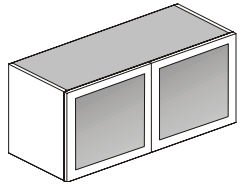
Description	Model	Dimensions			Wgt	List Prices WoodPlus ²	
		Deep	Long	High			
E2 Overheads							
 <p>Flipper Door Wall Mount, 30" to 60" wide</p>	One flipper door	E2-OW-153016-FDT	14.75	30	16	46	727
		E2-OW-153616-FDT	14.75	36	16	53	799
		E2-OW-154216-FDT	14.75	42	16	60	864
		E2-OW-154816-FDT	14.75	48	16	67	914
		OPTION-LOCK-FLIPPER-DOOR					87
Add '-LOCK' to model number to lock doors.							
	Two flipper doors	E2-OW-155416-FDT	14.75	54	16	74	1137
		E2-OW-156016-FDT	14.75	60	16	81	1174
		OPTION-LOCK-FLIPPER-DOORS					174
	Add '-LOCK' to model number to lock doors						
 <p>Hinged Door Wall Mount, 30" to 60" wide</p>	One pair hinged doors	E2-OW-153016-HDT	14.75	30	16	46	727
		E2-OW-153616-HDT	14.75	36	16	53	799
		E2-OW-154216-HDT	14.75	42	16	60	864
		E2-OW-154816-HDT	14.75	48	16	67	914
		LOCK-ONE-PAIR-DOORS					87
Add '-LOCK' to model number to lock doors. Specify Pull.							
	Two pair hinged doors	E2-OW-155416-HDT	14.75	54	16	74	1137
		E2-OW-156016-HDT	14.75	60	16	81	1174
		LOCK-TWO-PAIR-DOORS					174
	Add '-LOCK' to model number to lock doors. Specify Pull.						
 <p>Shaped hinged door Wall Mount, 30" to 48" wide</p>	Shaped hinged doors	E2-OW-153016-SDT	14.75	30	16	46	798
		E2-OW-153616-SDT	14.75	36	16	53	870
		E2-OW-154216-SDT	14.75	42	16	60	935
		E2-OW-154816-SDT	14.75	48	16	67	985
	Pulls and Locks are not available on shaped doors						
 <p>Shaped hinged door Wall Mount, 54" or 60" wide</p>	Center shaped hinged doors	E2-OW-155416-SDT	14.75	54	16	74	1208
		E2-OW-156016-SDT	14.75	60	16	81	1245
	Pulls and Locks are not available on shaped doors						
	Glass doors	EQ-OW-153016-HGWT	14.75	30	16	46	1094
	WoodPlus² frame	EQ-OW-153616-HGWT	14.75	36	16	53	1178
		EQ-OW-154216-HGWT	14.75	42	16	60	1288
		EQ-OW-154816-HGWT	14.75	48	16	67	1455
	Two pair of doors	EQ-OW-155416-HGWT	14.75	54	16	74	1814
		EQ-OW-156016-HGWT	14.75	60	16	81	1852
Pulls and Locks are not available on glass doors							
GW = Glass doors with WoodPlus ² frame. GW doors use frosted glass.							
For clear glass, please add List \$210 per unit and add '-CLEAR' to model number.							

EQUATIONS² Shapes - Component Pricing

Description	Model	Dimensions			Wgt	List Prices WoodPlus ²
		Deep	Long	High		



E2 Overheads tackboards, wall mounted

Note: Our fabric usage is updated. All fabrics are now installed on tackboards with the 'direction' (the length of the fabric as it is pulled off the roll) vertical.

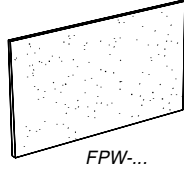

Tackboards	Model	Deep	Long	High	Wgt	List Prices	
18 high	FPW-30L-18H	0.5	30	18	5	222	
	FPW-36L-18H	0.5	36	18	5	222	
	FPW-42L-18H	0.5	42	18	5	222	
	FPW-48L-18H	0.5	48	18	5	222	
	FPW-54L-18H	0.5	54	18	10	222	
	FPW-60L-18H	0.5	60	18	10	222	
	FPW fabric panels that are 66" or longer are made in two pieces.						
		FPW-66L-18H	0.5	66	18	10	254
		FPW-72L-18H	0.5	72	18	10	254
		FPW-78L-18H	0.5	78	18	10	286
	FPW-84L-18H	0.5	84	18	10	286	
	FPW-90L-18H	0.5	90	18	10	286	
	FPW-96L-18H	0.5	96	18	10	286	

18" high panels fit between worktop and wall mounted overhead when overhead aligns with standard height hutch or 65 high tower.

Tackboards "FPW" are shipped in two pieces when 66" or longer.

Tackboards	Model	Deep	Long	High	Wgt	List Prices	
25 high	FPW-30L-25H	0.5	30	25	7	222	
	FPW-36L-25H	0.5	36	25	7	222	
	FPW-42L-25H	0.5	42	25	7	222	
	FPW-48L-25H	0.5	48	25	7	222	
	FPW-54L-25H	0.5	54	25	12	222	
	FPW-60L-25H	0.5	60	25	12	222	
	FPW fabric panels that are 66" or longer are made in two pieces.						
		FPW-66L-25H	0.5	66	25	12	254
		FPW-72L-25H	0.5	72	25	12	254
		FPW-78L-25H	0.5	78	25	12	286
	FPW-84L-25H	0.5	84	25	12	286	
	FPW-90L-25H	0.5	90	25	12	286	
	FPW-96L-25H	0.5	96	25	12	286	

25" high panels fit between worktop and wall mounted overhead when overhead aligns with extended height hutch or 72 high tower.

Tackboards "FPW" are shipped in two pieces when 66" or longer.

FPW- to 60" long - 18" or less in height	222
FPW- to 60" long - 25" or less in height	222
FPW- to 60" long - over 25" in height	254

Most standard Guilford Panel Fabrics are available on MagnaFLEX lead time.

If the fabric is not listed in our specifications (see www.magnadesign.com), please contact factory for Fabric Grade, availability, lead time and pricing.

Pricing shown is for Magna designated Fabric Grades A, B and C.

For COM fabric, please use the pricing shown above. A sample of the COM fabric plus the fabric specifications such as width of roll, directional or non-directional is required.

Tasklights are available in Accessories at back of pricelist.

EQUATIONS² Shapes - Component Pricing

Description	Model	Dimensions			Wgt	List Prices WoodPlus ²
		Deep	Long	High		



E2 Tables Mobiles



E2-TD-4629-COLX

Column base	E2-TD-4229-COLX	42	42	29	75	1010
	E2-TD-4629-COLX	46	46	29	93	1120

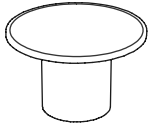

E2-TD-4629-CYL

Cylinder base	E2-TD-4229-CYL	42	42	29	140	1298
	E2-TD-4629-CYL	46	46	29	155	1384
	OPTION-GRC	1.75	3.5			48

For a center grommet in top, add '-GRC' to the model name.

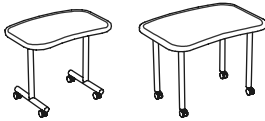

Kidney tables	E2-TK-243629-TLEG-CA	24	36	29	53	869
	E2-TK-304229-C2-CA	30	42	29	66	1031

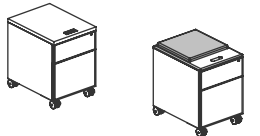

Cushion Option

Mobile 3/4 pedestal	E2-PM-211622-BF-CA	20	16	27	82	1190
	OPTION-EQ-PM-CUSHION	16	20	1	5	101

E2-PM Box File pedestal on casters with lock may be stored underneath a worktop.

Specify Pull.

Optional black cushion may be ordered for the top of the E2-PM case, add '-CUSH' to model number.

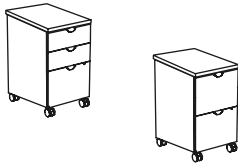

Worksurface height mobile pedestal	E2-PD-TT-241629-BBF-CA	24	16	29	94	1261
	E2-PD-TT-241629-FF-CA	24	16	29	94	1261

E2-PD mobile pedestals include a worktop 24 deep and 16 wide.

E2-PD pedestal can be 'docked' next to a worktop to extend the worktop surface.

Specify Pull.

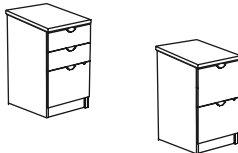

Pedestal with top	E2-PD-TT-241629-BBF	24	16	29	94	1035
	E2-PD-TT-241629-FF	24	16	29	94	1035

A worktop at 24 deep and 16 long is included.

This pedestal can be 'docked' next to a worktop to extend the worktop surface.

Specify Pull.

EQUATIONS² Shapes - Component Pricing

Description	Model	Dimensions			Wgt	List Prices WoodPlus ²
		Deep	Long	High		



Lateral File and Combo Components

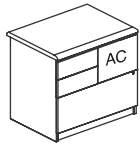

Combo A	E2-CR-TT-243229-AC	24	32	29	166	1532
Includes one LF drawer and one File drawer, both locked. Two Box drawers are not locked. Specify Pulls.						

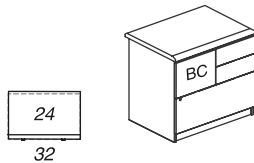

Combo B	E2-CR-TT-243229-BC	24	32	29	166	1532
Includes one LF drawer and one File drawer, both locked. Two Box drawers are not locked. Specify Pulls.						

Freestanding Lateral File cabinet, with lock

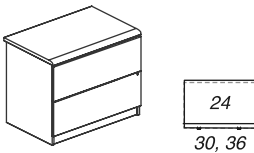

Lateral File	E2-CR-TT-243029-LF	24	30	29	162	1506
	E2-CR-TT-243629-LF	24	36	29	167	1561
Two drawer lateral file cabinet with lock. Specify Pull.						

Front edge is WoodPlus2 top edge profile.

When placing these units next to an Equations² Shapes credenza, specify front edge with 'top joint edge' to match the credenza top detailing.

Lateral File drawers with hutch storage above

2 Lateral File drawers with hutch

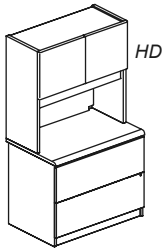

Hinged doors 65 high	E2-HL-TI-243065-HD-2LF	24	30	65	248	2553
	E2-HL-TI-243665-HD-2LF	24	36	65	260	2622
	OPTION-LOCK-PAIR-DOORS					87
Overall height matches standard height hutch or bookcase at 65 high.						

Hinged doors 72 high	E2-HL-TI-243072-HD-2LF	24	30	72	248	2634
	E2-HL-TI-243672-HD-2LF	24	36	72	260	2714
	OPTION-LOCK-PAIR-DOORS					87
Two lateral file drawers are locked. Hutch has hinged doors. Specify Pull. Overall height matches extended height hutch or bookcase at 72 high.						

Shaped hinged doors 65 high	E2-HL-TI-243065-SD-2LF	24	30	65	250	2624
	E2-HL-TI-243665-SD-2LF	24	36	65	262	2693
Overall height matches standard height hutch or bookcase at 65 high.						

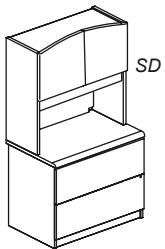

Shaped hinged doors 72 high	E2-HL-TI-243072-SD-2LF	24	30	72	250	2705
	E2-HL-TI-243672-SD-2LF	24	36	72	262	2785
Two lateral file drawers are locked. Specify Pull. Hutch has shaped hinged doors. No applied pull or lock available for shaped doors. Overall height matches standard height hutch or bookcase at 72 high.						

Glass doors 65 high	E2-HL-TI-243065-GW-2LF	24	30	65	248	2869
	E2-HL-TI-243665-GW-2LF	24	36	65	260	2939
Overall height matches standard height hutch or bookcase at 65 high.						

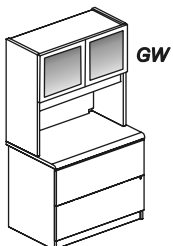

Glass doors 72 high	E2-HL-TI-243072-GW-2LF	24	30	72	248	2951
	E2-HL-TI-243672-GW-2LF	24	36	72	260	3031
Two lateral file drawers are locked. Specify Pull. Hutch glass doors with WoodPlus2 frames. No applied pull or lock available for glass doors Overall height matches extended height hutch or bookcase at 72 high.						

Front edge is WoodPlus2 top edge profile.

When placing these units next to an Equations² Shapes credenza, specify front edge with 'top joint edge' to match the credenza top detailing.

EQUATIONS² Shapes - Component Pricing

Description	Model	Dimensions			Wgt	List Prices WoodPlus ²
		Deep	Long	High		



Three and four drawer Lateral File cabinets

Three and Four Drawer
Lateral Files

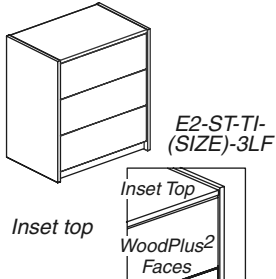

Inset top	E2-ST-TI-243041-3LF	24	30	41	284	2162
	E2-ST-TI-243641-3LF	24	36	41	292	2211

Three lateral file drawers are locked and are inset between tower ends. Specify Pull. Cabinet top is inset between ends. Cabinet top finish matches case finish.

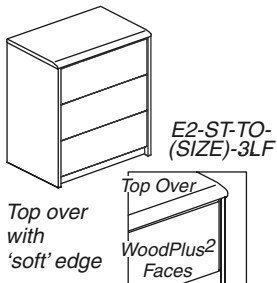

Top Over	E2-ST-TO-243041-3LF	24	30	41	284	2327
	E2-ST-TO-243641-3LF	24	36	41	292	2408

Three lateral file drawers are locked and are inset between tower ends. Specify Pull. Cabinet top over matches worktop finish and detailing.

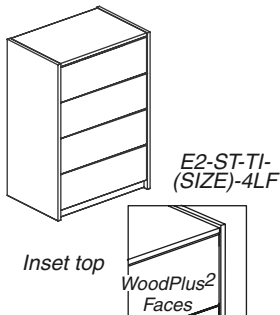

Inset top	E2-ST-TI-243053-4LF	24	30	53	288	2578
	E2-ST-TI-243653-4LF	24	36	53	301	2650

Four lateral file drawers are locked and are inset between tower ends. Specify Pull. Cabinet top is inset between ends. Cabinet top finish matches case finish.

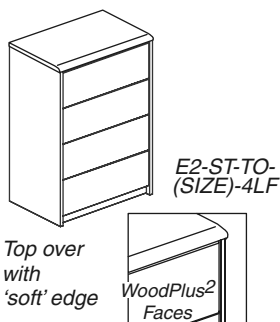

Top over	E2-ST-TO-243053-4LF	24	30	53	288	2760
	E2-ST-TO-243653-4LF	24	36	53	301	2842

Four lateral file drawers are locked and are inset between tower ends. Specify Pull. Cabinet top over matches worktop finish and detailing.

EQUATIONS² Shapes - Component Pricing

Description Model

Dimensions
Deep Long High

Wgt

 List Prices
WoodPlus²

E2 Bookcases

Bookcases

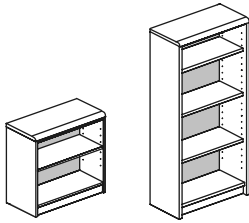

E2-ST-TO-(SIZE)-BCK

Description	Model	Deep	Long	High	Wgt	List Prices
Top over black back	E2-ST-TO-153029-BCK	15	30	29	89	779
	E2-ST-TO-153036-BCK	15	30	36	98	839
	E2-ST-TO-153042-BCK	15	30	42	108	866
	E2-ST-TO-153048-BCK	15	30	48	125	892
	E2-ST-TO-153060-BCK	15	30	60	140	919
	E2-ST-TO-153065-BCK	15	30	65	156	945
	E2-ST-TO-153072-BCK	15	30	72	156	991
	E2-ST-TO-153084-BCK	15	30	84	212	1036

Cabinet top over matches worktop finish and detailing.

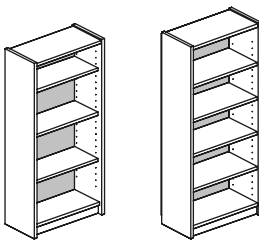

E2-ST-TI-(SIZE)-BCK

Top inset black back	E2-ST-TI-153036-BCK	15	30	36	98	733
	E2-ST-TI-153042-BCK	15	30	42	108	760
	E2-ST-TI-153048-BCK	15	30	48	125	786
	E2-ST-TI-153060-BCK	15	30	60	140	813
	E2-ST-TI-153065-BCK	15	30	65	156	839
	E2-ST-TI-153072-BCK	15	30	72	156	885
	E2-ST-TI-153084-BCK	15	30	84	212	930

Cabinet top is inset between ends. Cabinet top finish matches case finish.

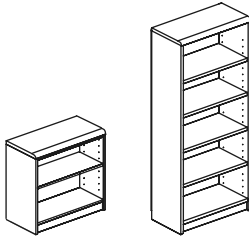

E2-ST-TO-(SIZE)-BCB

Top over matching back	E2-ST-TO-153029-BCB	15	30	29	89	825
	E2-ST-TO-153036-BCB	15	30	36	98	886
	E2-ST-TO-153042-BCB	15	30	42	108	946
	E2-ST-TO-153048-BCB	15	30	48	125	1007
	E2-ST-TO-153060-BCB	15	30	60	140	1067
	E2-ST-TO-153065-BCB	15	30	65	156	1132
	E2-ST-TO-153072-BCB	15	30	72	156	1177
	E2-ST-TO-153084-BCB	15	30	84	212	1223

Cabinet top over matches worktop finish and detailing.

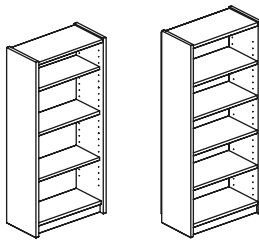

E2-ST-TI-(SIZE)-BCB

Top inset matching back	E2-ST-TI-153036-BCB	15	30	36	98	780
	E2-ST-TI-153042-BCB	15	30	42	108	840
	E2-ST-TI-153048-BCB	15	30	48	125	901
	E2-ST-TI-153060-BCB	15	30	60	140	961
	E2-ST-TI-153065-BCB	15	30	65	156	1026
	E2-ST-TI-153072-BCB	15	30	72	156	1071
	E2-ST-TI-153084-BCB	15	30	84	212	1117

Cabinet top is inset between ends. Cabinet top finish matches case finish.

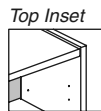
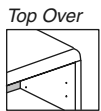
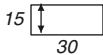

NOTES:

- 29 high matches worktop height.
- 29 high includes one adjustable shelf (does not accommodate two rows of binders)
- 36 high includes one adjustable shelf.
- 42, 48 high includes two adjustable shelves.
- 60, 65 high includes three adjustable shelves.
- 72 includes four adjustable shelves.
- 84 includes five adjustable shelves.

Adjustable shelves are 13 1/2" deep. Weight limit is 100 lbs per shelf.

36" wide bookcases are available at the same price, change the 30 to 36 in the model number.

EQUATIONS ACCESSORIES

Description	Model	Dimensions			Wgt	List Prices WoodPlus ²
		Deep	Long	High		

Keyboard Trays

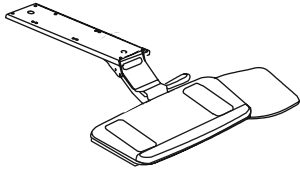

Adjustable Keyboard Tray, Mouse Extension	RKT-ME	11	30	0.75	20	263
		Mouse extension can be used to left or right. Extension is 9 wide, 8-1/2 deep and 3/8 high. Space required for mounting: 30 wide, 17-3/4 deep and 3-3/4 high. Finish is black.				

Keyboard Corner

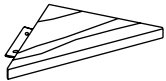

Keyboard Corner	EQ-KC-1212	12	21	1.125	8	184
		Only available for Equations Standard layouts. Installation hardware included. Finish matches top finish.				

Not available for Equations2 or Equations2 Shapes layouts.

Center Drawer

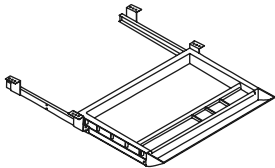

Center Drawer	CDM-21	17	21	1.75	2	44
		Black moulded drawer.				

Corner Shelf, quarter round

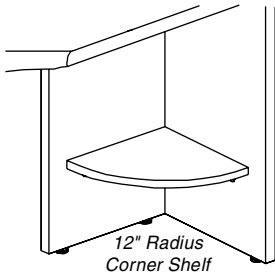

Quarter Round Shelf	CSR-12	12	12	0.75	6	118
		Includes brackets to install the quarter round shelf in a corner.				

Wire Management

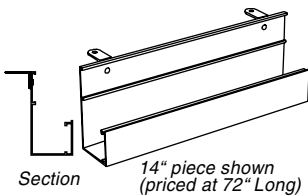

J track	MJT-MP	2.5	72	5	4	66
Wiremanager	MJT-WS	2.5	72	5	4	66
		MJT-MP mounts on Modesty Panel. MJT-WS mounts on Worksurface, includes brackets.				

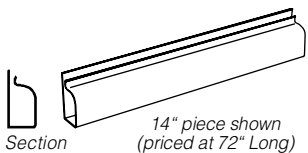

Wiremanager	WM	1.25	72	2.5	3	37
		Cut to desired length(s); mount under work surface.				

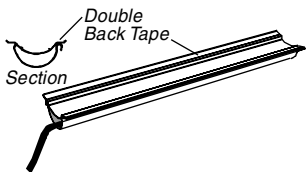

Self-stick Wiremanager	RMN-22	2.75	22		1	18
	RMN-96	2.75	96		4	49
		Extruded PVC with 'double-sided' tape included for installation.				

EQUATIONS ACCESSORIES

Description	Model	Dimensions			Wgt	List Prices WoodPlus ²
		Deep	Long	High		

Wire Management

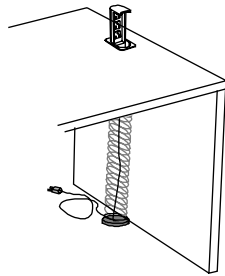

Coil Wire	CWM-BASE	3	3	1	2	58
Manager	CWM-WIRE-MANAGER	2	2	27	3	48

Does not include grommet or grommet cutout.
Mounts to underside of top.
Optional CWM-BASE weighted base is available.
Black finish.

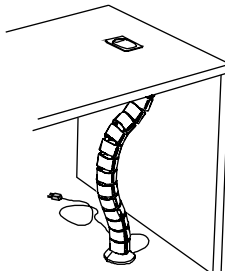

Vertebrae Wire	VWM-WIRE-MANAGER	2	2	27	4	117
Manager						

Does not include grommet or grommet cutout.
Mounts to underside of top.
Weighted base is included.
Black finish.



Grommet	GR	1.75	3.5			48
----------------	-----------	------	-----	--	--	-----------

Grommet opening: 1-3/4 x 3-1/2.
Specify Location. Left End, GREL, Right End, GRER or Center, GRC.

Tasklights

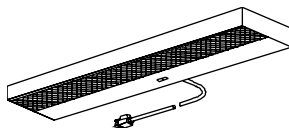

Tasklights	WL24	7	21	2	3	79
	WL30	7	27	2	3	86
	WL36	7	33	2	3	99
	WL42	7	39	2	4	108
	WL48	7	45	2	5	115

Includes 8 feet long cord extending from center back of light. Work lights have built-in diffusers.

Pop-up INSERTS that can be used in grommet cutouts

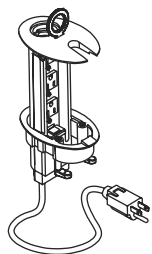

Work Height	WHT-INSERT	1.75	3.5	5	1	148
Triplex						

The WHT INSERT is used in an existing grommet cutout. Order Grommet separately.
WHT is a work surface pop-up with three outlets and is provided with a 6 foot cord.
Pull-up size: 1-3/4 x 3-1/2 x 5-1/8 high when extended.
Finish is satin Black.

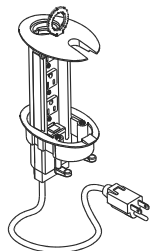

Power Data	PDC-INSERT	1.75	3.5	5	1	138
Combination						

The PDC INSERT is used in an existing grommet cutout. Order Grommet separately.
PDC is a work surface pop-up with two outlets; it accepts one receptacle plate to be supplied by your electrical contractor or supplier.
PDC does not include any receptacles or receptacle plates.
Pull-up size: 1-3/4 x 3-1/2 x 5-1/8 high when extended.
Finish is satin Black.

EQUATIONS ACCESSORIES

Description	Model	Dimensions			Wgt	List Prices WoodPlus ²
		Deep	Long	High		

Pop-up INSERTS that can be used in grommet cutouts

Data Voice	DVR-INSERT	1.75	3.5	5	1	66
-------------------	-------------------	------	-----	---	---	-----------

Receptacle The DVR INSERT is used in an existing grommet cutout. Order Grommet separately.

DVR is a work surface pop-up that accepts various receptacle plates to be supplied by your electrical contractor or supplier. DVR does not include any receptacles or receptacle plates. Pull-up size: 1-3/4 x 3-1/2 x 5-1/8 high when extended. Finish is satin Black.

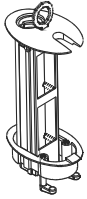

Handy Access	HAD-INSERT	3.13	8.4	2.8	0	177
---------------------	-------------------	------	-----	-----	---	------------

Double The HAD INSERT is used in an existing grommet cutout. Order Grommet separately.

HAD is an insert with two outlets and it accepts two couplers / jacks to be supplied by your electrical contractor or supplier. HAD does not include any receptacles or receptacle plates. Adapters included to fit coupler / jack into HAS opening are supplied for AT&T / Lucent Cat 5, Amp Cat 5, Amp Cat 3, Panduit Cat 5, Allen Tel Cat 5, Krone Cat 5, Hubbell Cat 5. Finish is satin Black.

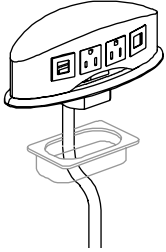

INTERPORTS and MINIPORTS with plug in power cords

INTERPORT	INTERPORT-PLUG-120	3	7	2	2	236
------------------	---------------------------	---	---	---	---	------------

with PLUG

Interport provides work surface height power and data distribution and can be installed side by side. Cords slip through holes, and unit may be used in open or closed position. Includes 2 simplexes, 2 voice/data ports and 10' , 15 amp cord. UL listed. Because of larger cutout required, please call Customer Service to confirm available clearance.

INTERPORT_PLUG does not include any receptacles. Blank receptacle adapters are included.

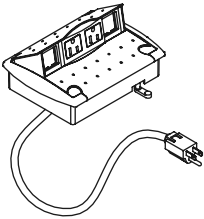

MINIPOINT	MINIPOINT-PLUG-120	5	7	2	2	197
------------------	---------------------------	---	---	---	---	------------

with PLUG

Miniport provides work surface height power and data distribution and can be installed side by side. Cords slip through holes, and unit may be used in open or closed position. Includes 2 simplexes, 2 voice/data ports and 10' , 15 amp cord. UL listed. Because of larger cutout required, please call Customer Service to confirm available clearance.

MINIPOINT-PLUG does not include any receptacles. Blank receptacle adapters are included.

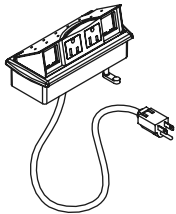

EQUATIONS and EQUATIONS² Table of Contents

Pricing and Delivery	4
Warranty	4
Terms and Conditions	5
Fuel Surcharge	5

Accessories

DTO- Desk top organizers and trays	29
RKT-ME Keyboard tray	94
EQ-KC Equations Standard keyboard corner	94
CDM-21 Center Drawer	94
CSR-12 Corner shelf, quarter round	94
MJT- Wiremanager	94
WM Wiremanager	94
RMN Wiremanager	94
CWM- Wiremanager	95
VWM- Wiremanager	95
GR Grommet	95
WL Tasklights	95
WHT- Insert for GR Grommet	95
PDC- Insert for GR Grommet	95
DVR- Insert for GR Grommet	96
HAD- Insert for GR Grommet	96
INTERPORT-PLUG-120Worktop power - data insert	96
MINIPOINT-PLUG-120Worktop power - data insert	96

Hardware

SPLICE- Splice Plate Ovals to connect worktops	49
AB- Angle Bracket at 8" long	49
SPL-AB Splice Plate Oval and Angle Bracket	49
EQ-TOPRAIL-Worktop support rails	49

Equations Standard models, begin with EQ-...

Equations Standard specifications	6
How to Layout Equations Standard components	9
How to Layout Equations Standard parts	40 - 42
Finishes: WoodPlus and WoodPlus XTRA	9, 43
Edge profiles	9, 43
Pulls	9, 43
Grommets locations in worktops	10
Tapered Led option	10
CBP Column Base Plate option for 4.5" column	10
Equations Standard configurations	11
EQ-101	11
EQ-102	11
EQ-103	11
EQ-104	11
EQ-105	12
EQ-106	12
EQ-107	12
EQ-108	12
EQ-109	12
Equations Standard component overview	13
EQ-D- Desks	14 - 19
EQ-CNR- Corner Components	19
EQ-R- Returns	20 - 21
EQ-DE- Desk extensions, shaped tops	21 - 22
EQ-B- Bridge	22
EQ-CR- Credenzas	23 - 25
EQ-H- Hutches	26 - 28
EQ-OW- Overhead cabinets, wall mounted	30
EQ-TD- Round tables	32
EQ-R-CE- Extension top	32
EQ-TK- Kidney shaped tables with casters	32
EQ-MLS- Mobile laptop desk and storage	32
EQ-PM- Mobile pedestal, Box File layout	32
EQ-PD- Mobile pedestal with worktop, BBF or FF layout	32
EQ-CR- Credenzas	33
EQ-ST- Towers with lateral file drawers	33 - 34
EQ-ST- Bookcases	36
EQ-ST- Towers with optional doors	37
EQ-STV- AV Towers with optional doors	38
EQ-HL- Lateral file with hutch above	35
EQ-RD- Reception Desk	39
EQ-TOP- Worktops	44 - 45
EQ-PED- Pedestals	46
EQ-CAB- Cabinets	46 - 47
EQ-EP- End Panels with mounting brackets	48
EQ-MP- Modesty Panels	48
FPI Hutch Tackboards	29
FWP Wall mounted Tackboards	31
TVT Pullout TV tray for EQ-STV- AV towers	39

EQUATIONS and EQUATIONS² Table of Contents

Equations2 models, begin with E2-...

Equations2 specifications	7
How to Layout Equations2 components	50
Finishes: WoodPlus2 and WoodPlus2 XTRA	50
Edge profiles	50
Pulls	50
Grommets locations in worktops	51
Tapered Led option	51
CBP Column Base Plate option for 4.5" column	51
Equations2 configurations	52
E2-101	52
E2-102	52
E2-103	52
E2-104	52
E2-105	53
E2-106	53
E2-107	53
E2-108	53
E2-109	53
Equations2 component overview	54
E2-D- Desks	55 - 60
E2-CNR- Corner Component	61
E2-R- Returns	61 - 63
E2-B- Bridge	63
E2-CR- Credenzas	64 - 66
E2-H- Hutches	67 - 68
E2-OW- Overheads, wall mounted	70
E2-TD- Round tables	72
E2-TK- Kidney tables with casters	72
E2-PM- Mobile pedestal, Box File layout, casters	72
E2-PD- Docking pedestals with worktop	72
E2-CR- Credenzas	73
E2-HL- Lateral file with hutch above	73
E2-ST- Towers with Lateral File drawers	74
E2-ST- Bookcases	75
FPI Hutch Tackboards	69
FPW Tackboards, wall mounted	71

Equations2 Shapes models, begin with ES-...

Equations2 Shapes specifications	7
How to Layout Equations2 Shapes components	76
Finishes: WoodPlus2 and WoodPlus2 XTRA	76
Edge profiles	76
Pulls	76
Grommets locations in worktops	77
Tapered Led option	77
Equations2 Shapes configurations	78
ES-101	78
ES-102	78
ES-103	78
ES-104	78
ES-105	79
ES-106	79
ES-107	79
ES-108	79
ES-109	79
Equations2 Shapes component overview	80
ES-D- Desks	81 - 83
ES-R- Returns	84
ES-B- Bridge	83
ES-CR- Credenzas	85 - 86
ES-H- Hutches	87
E2-OW- Overheads, wall mounted	88
E2-TD- Round tables	90
E2-TK- Kidney tables with casters	90
E2-PM- Mobile pedestal, Box File layout, casters	90
E2-PD- Docking pedestals with worktop	90
E2-CR- Credenzas	91
E2-HL- Lateral file with hutch above	91
E2-ST- Towers with Lateral File drawers	92
E2-ST- Bookcases	93
FPI Hutch Tackboards	87
FPW Tackboards, wall mounted	89